

APPENDIX H—STATION GARNW

Station Name: **GARNW**
 (West side of Garnet Point)
 Position: Lat. 38°06'23"
 Long. 122°02'53"
 Depth: 2.4 m (MLLW)

Manufacturer	Serial Number	Deployment Dates
CTD: Ocean Sensors	OS200 306	9/18/95(261) - 10/23/95(296)
V: InterOcean	S408782105	9/18/95(261) - 10/23/95(296)
OBS: D & A	OBS3 681	9/18/95(261) - 10/23/95(296)

Serviced: 9/18/95(261), 10/23/95(296)

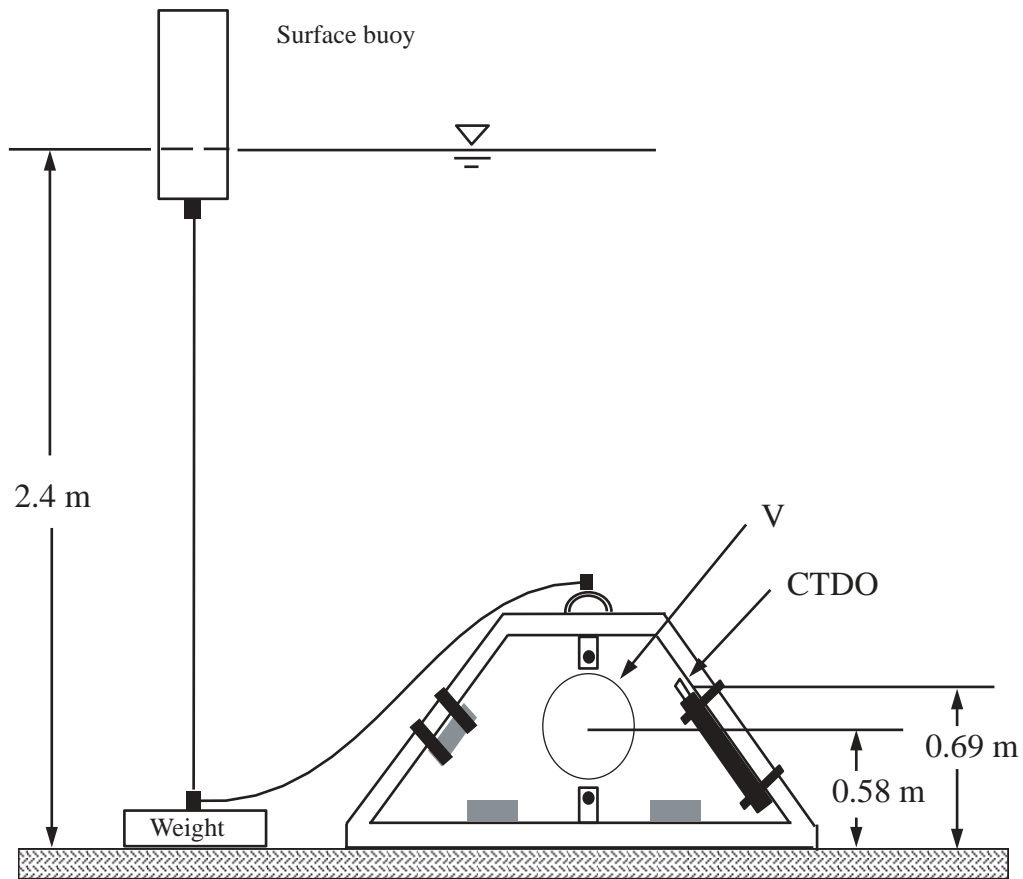

Figure H1. Configuration of instrument deployment, Station GARNW, September 18 through October 23, 1995, Suisun Bay, California. m, meters; MLLW, mean lower low water; OBS, optical backscatterance sensor; CTD, conductivity-temperature-depth-optical (backscatterance sensor); V, velocity.

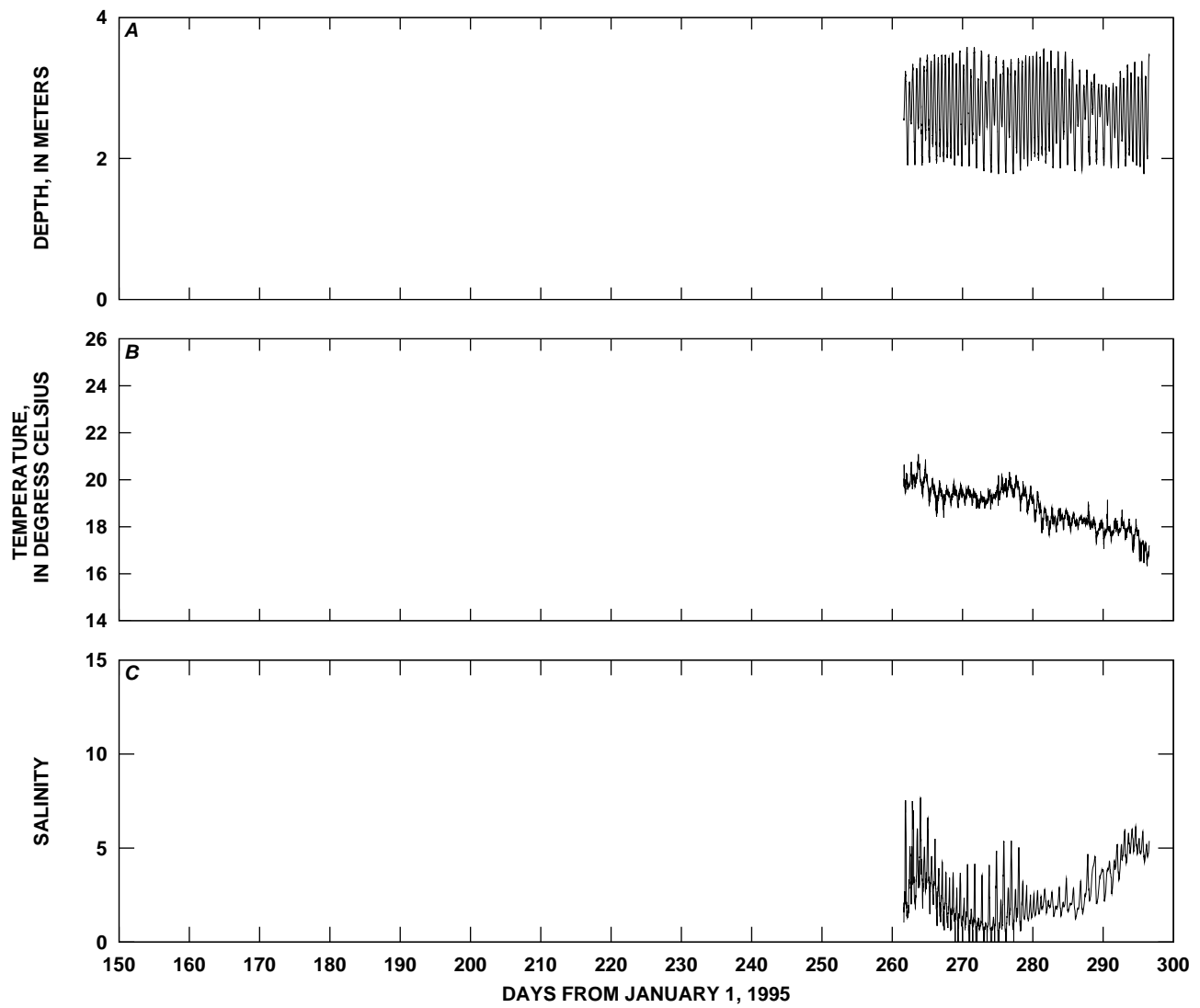

Figure H2. Time-series plots of *A*, depth; *B*, temperature; and *C*, salinity, Station GARNW, September 18 through October 23, 1995, Suisun Bay, California. Salinities in this report are presented without units because salinity is a conductivity ratio; therefore, it has no physical units (Millero, 1993).

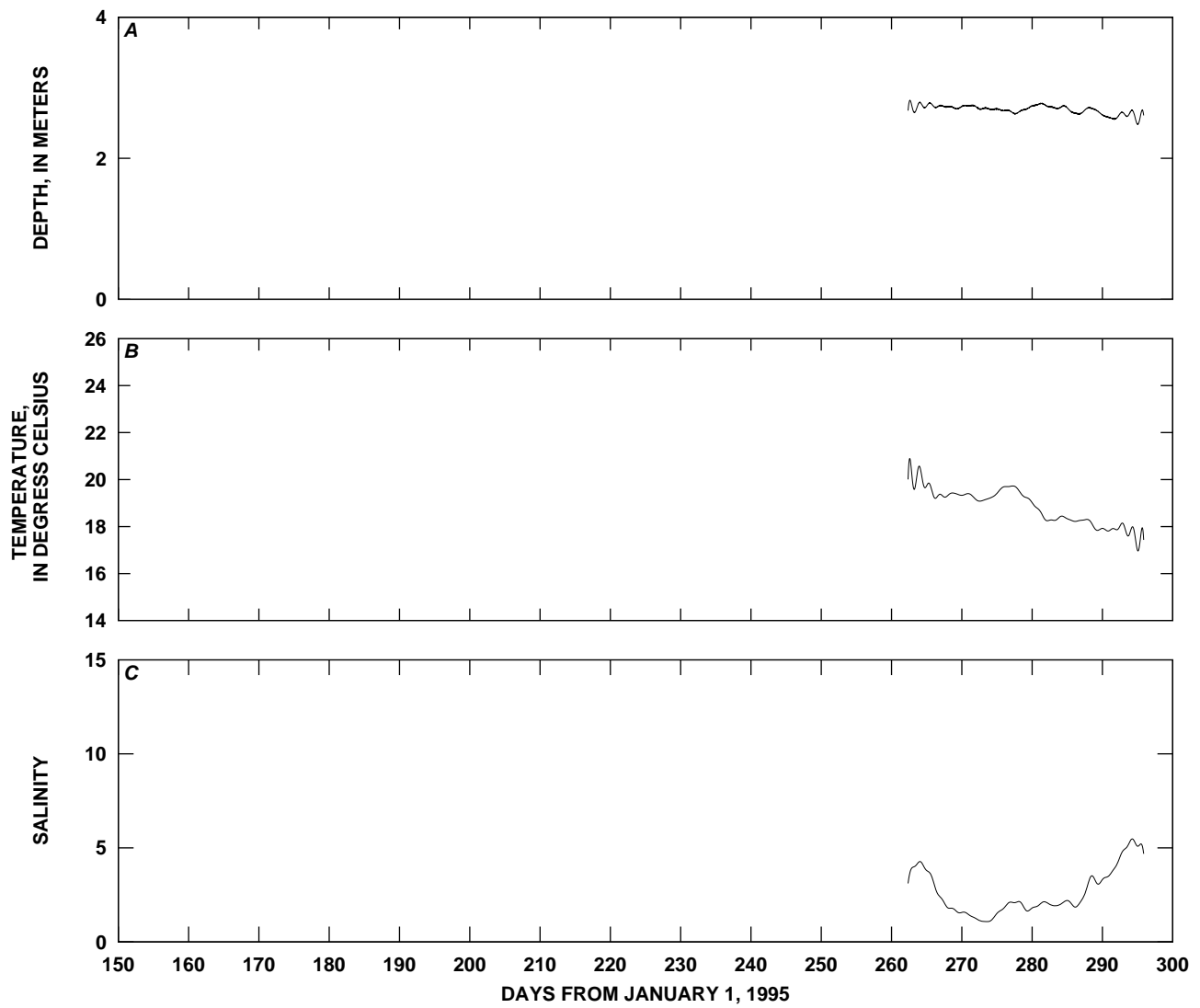

Figure H3. Time-series plots of low-pass-filtered *A*, depth; *B*, temperature; and *C*, salinity, Station GARNW, September 18 through October 23, 1995, Suisun Bay, California. Salinities in this report are presented without units because salinity is a conductivity ratio; therefore, it has no physical units (Millero, 1993).

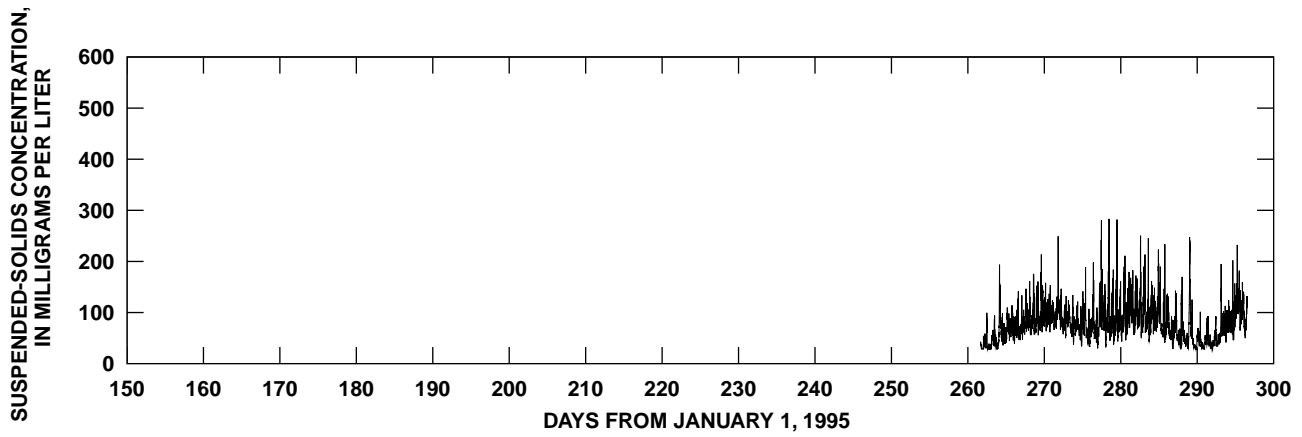

Figure H4. Time-series plot of suspended-solids concentration at Station GARNW, September 18 through October 23, 1995, Suisun Bay, California.

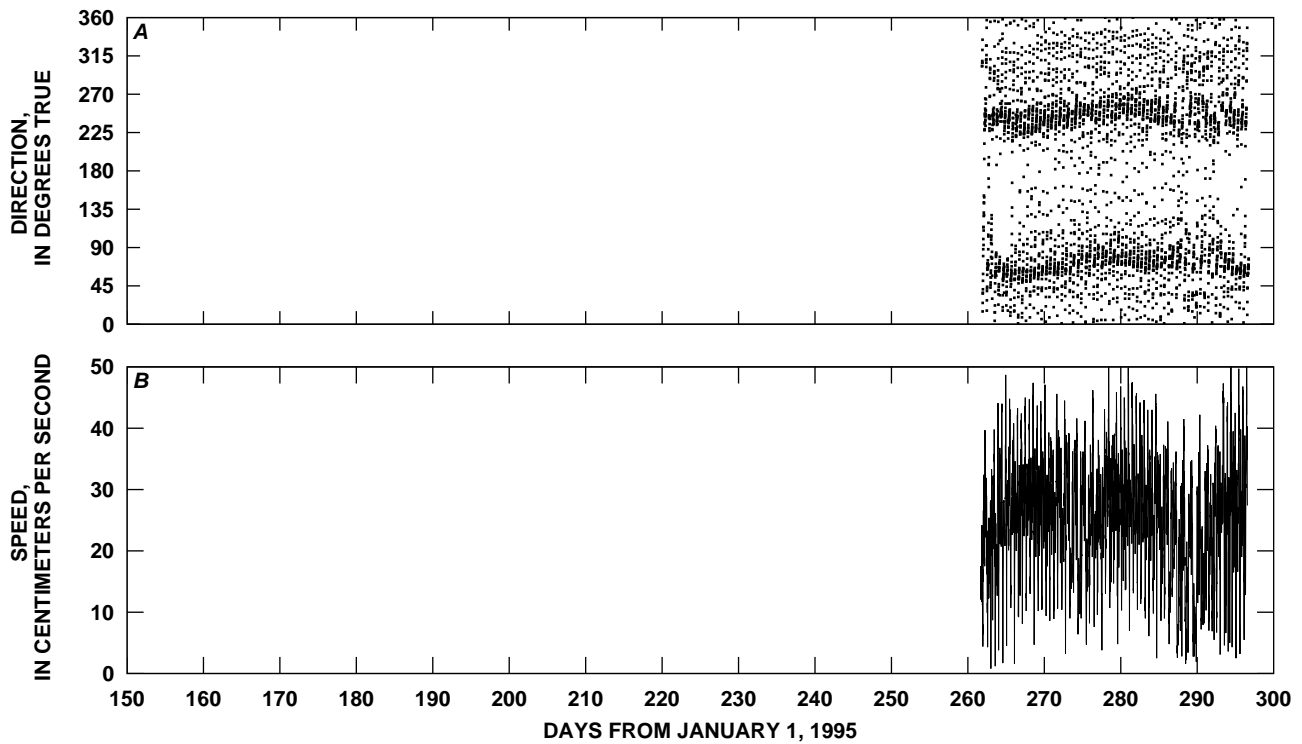

Figure H5. Time-series plots of tidal currents, Station GARNW, September 18 through October 23, 1995, Suisun Bay, California.

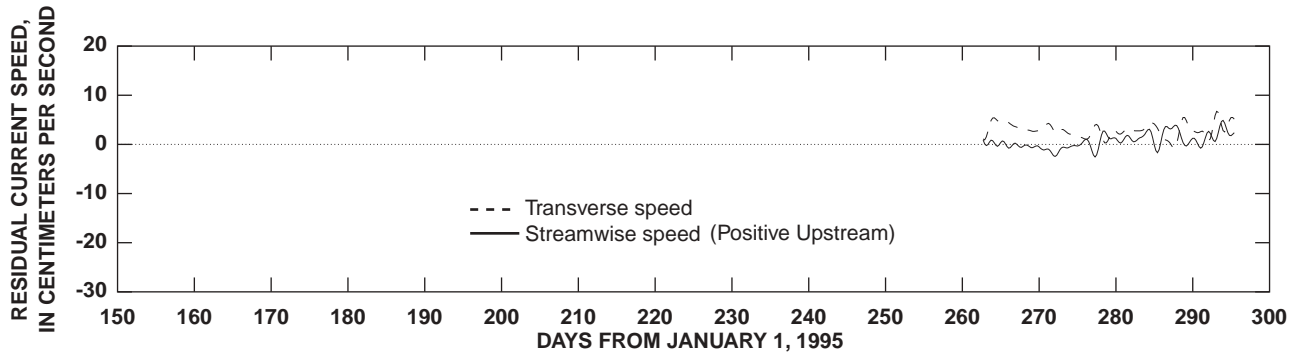

Figure H6. Longitudinal and transverse residual currents, Station GARNW, September 18 through October 23, 1995, Suisun Bay, California. Principal direction is 68.7 degrees true.

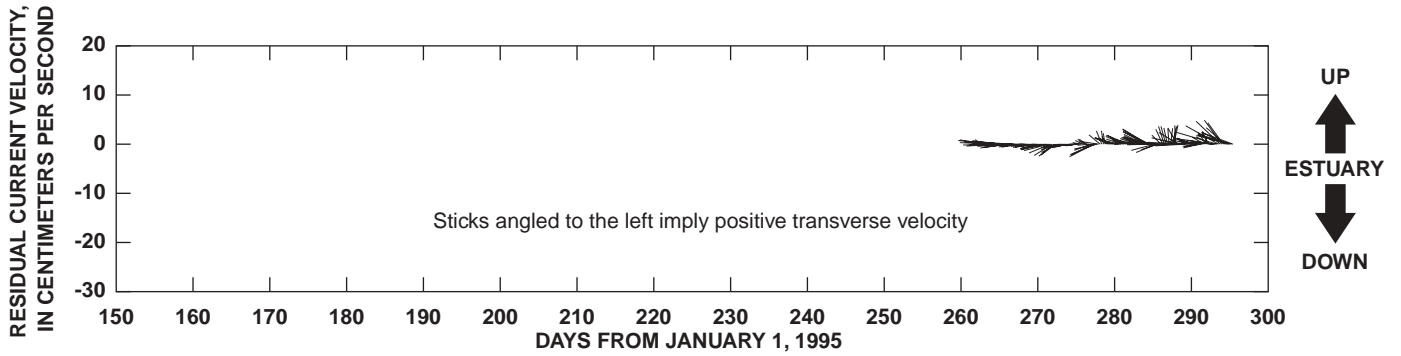

Figure H7. Residual currents, Station GARNW, September 18 through October 23, 1995, Suisun Bay, California. Principal direction is 68.7 degrees true.

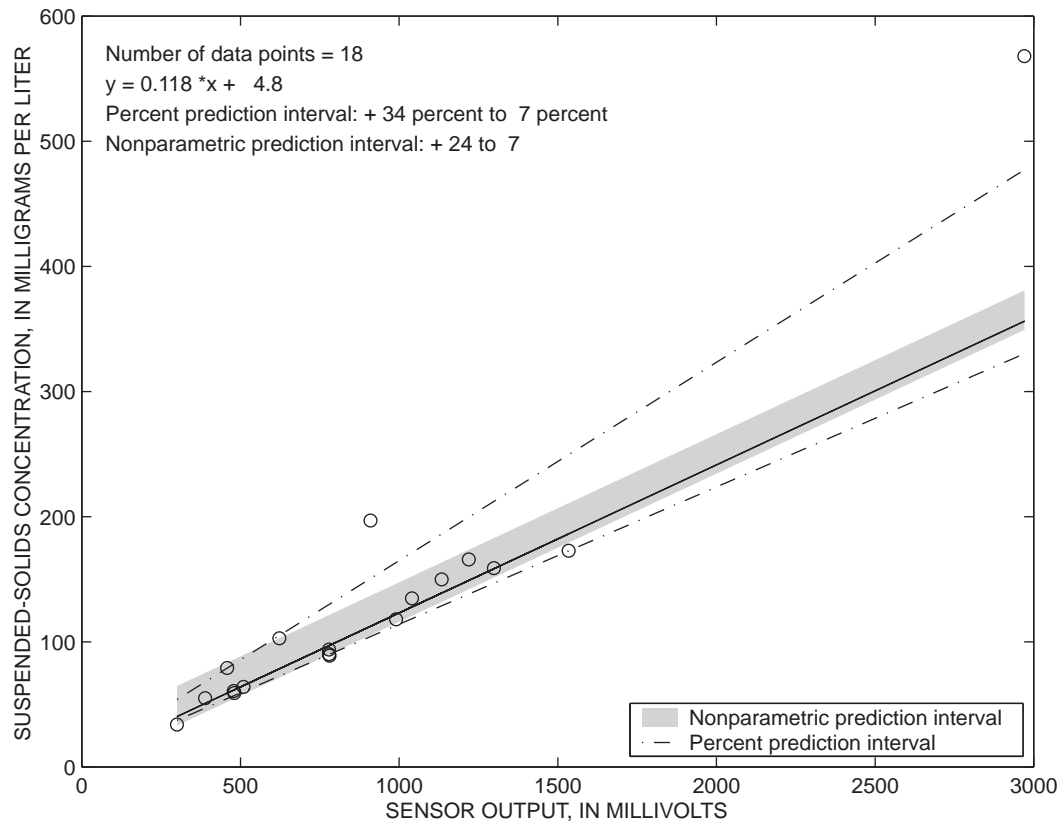

Figure H8. Calibration curve for near-bottom optical backscatterance sensor at Station GARNW, September 18 through October 23, 1995, Suisun Bay, California.

Table H1. Harmonic analysis results from depth measurements, Station GARNW, September 18 through October 23, 1995, Suisun Bay, California

Station: GARNW
Time series mean: 2.68836
Standard deviation: 0.08075
Harmonic constants: After tidal inference

Tidal symbol	Cycles (per day)	Mean amplitude (meters)	Local epoch (degrees)	Modified epoch (degrees)
Q1	0.89324	0.04148	130.11626	144.97501
O1	0.92954	0.21381	127.80892	138.31268
M1	0.96645	0.01518	125.48297	131.55748
P1	0.99726	0.11514	123.50592	125.88251
K1	1.00274	0.34787	123.15703	124.87654
Mu2	1.86455	0.01389	335.30704	355.65750
N2	1.89598	0.18791	14.26883	30.84711
Nu2	1.90084	0.03645	14.62994	30.62540
M2	1.93227	0.57861	16.96368	29.18698
L2	1.96857	0.01620	19.65854	27.52682
S2	2.00000	0.17187	58.62034	62.71644
K2	2.00548	0.04675	61.99453	65.43355
M4	3.86455	0.02206	302.08545	326.53198
Mk3	2.93501	0.01815	47.42136	61.36414

Table H2. Harmonic analysis results for velocity, Station GARNW, September 18 through October 23, 1995, Suisun Bay, California

[cm/s, centimeters per second; deg.T, degrees true; deg, degrees; E, equilibrium argument]

Station: GARNW
Start time of the series (local): Year, 95; Month,10; Day, 24; Hour, 0: 5
Record length: 34 M2 Cycle: 3351 data points

Tidal Symbol	Major axis (cm/s)	Minor axis (cm/s)	Direction (deg. T)	Phase (deg)	E (deg)	Rotation
O1	6.00	2.39	72.7	22.5	52.6	Clockwise
K1	8.70	2.24	70.7	226.9	293.1	Clockwise
N2	4.29	0.02	79.0	6.7	78.4	Counterclockwise
M2	30.11	12.14	68.8	102.4	345.7	Clockwise
S2	8.12	2.02	62.9	252.5	2.7	Clockwise
M4	4.29	0.26	116.0	228.9	331.5	Clockwise

Rootmeansquare speed, (cm/s): 26.82
Standard deviation, U series (cm/s): 6.33
Standard deviation, V series (cm/s): 4.95
Tidal form number: 0.38
Spring tidal current maximum (cm/s): 52.93
Neap tidal current maximum (cm/s): 19.28
Principal current direction (deg. T): 68.65

APPENDIX I—STATION GC

Station Name: **GC**
 (Grizzly Bay center)

Position: Lat. 38°07'12"

Long. 122°01'34"

Depth: 1.4 m (MLLW)

Manufacturer	Serial Number	Deployment Dates
CTD: Ocean Sensors	OS200 307	7/4/95(185) - 7/21/95(202)
Ocean Sensors	OS200 300	8/1/95(213) - 8/18/95(230)
V: InterOcean	S4 08782107	7/4/95(185) - 8/18/95(230)
OBS: D & A	OBS3 612	7/4/95(185) - 8/18/95(230)

Serviced: 7/4/95(185), 7/14/95(195), 7/17/95(198), 7/21/95(202), 8/1/95(213), 8/9/95(221), 8/18/95(230)

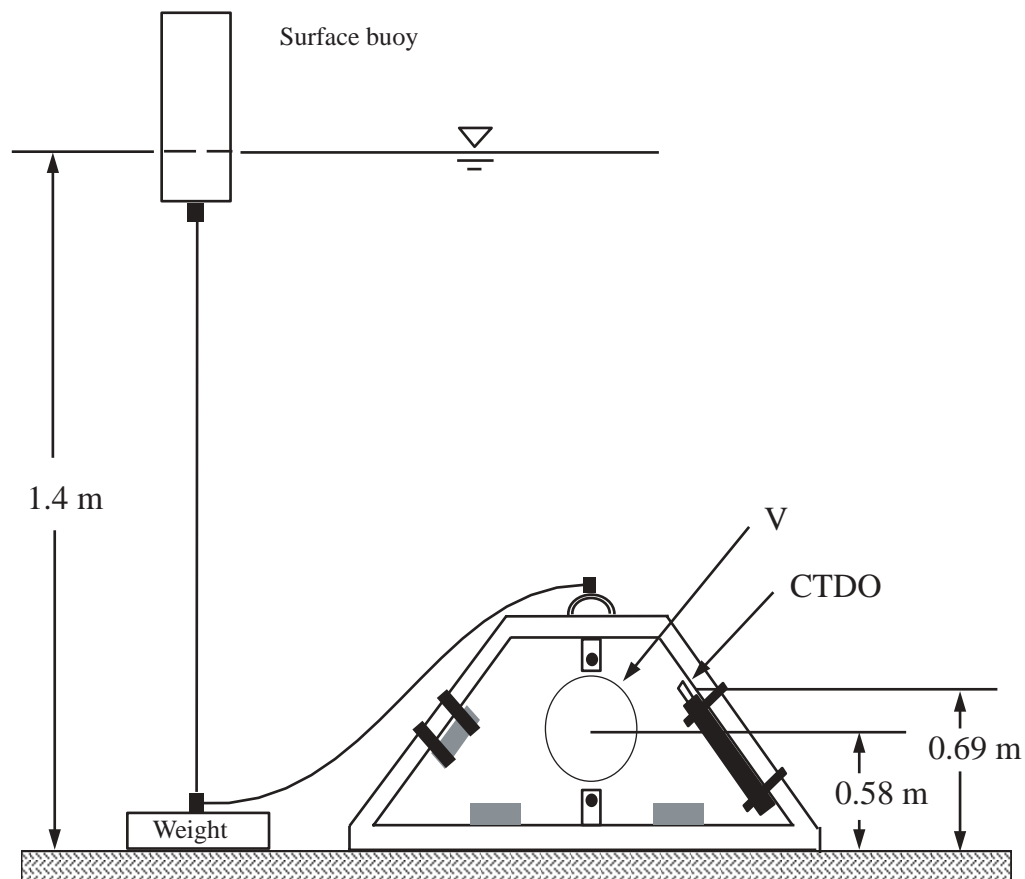

Figure 11. Configuration of instrument deployment, Station GC, July 4 through August 18, 1995, Suisun Bay, California. m, meters; MLLW, mean lower low water; OBS, optical backscatterance sensor; CTD, conductivity-temperature-depth; CTD-O, conductivity-temperature-depth-optical (backscatterance sensor); V, velocity.

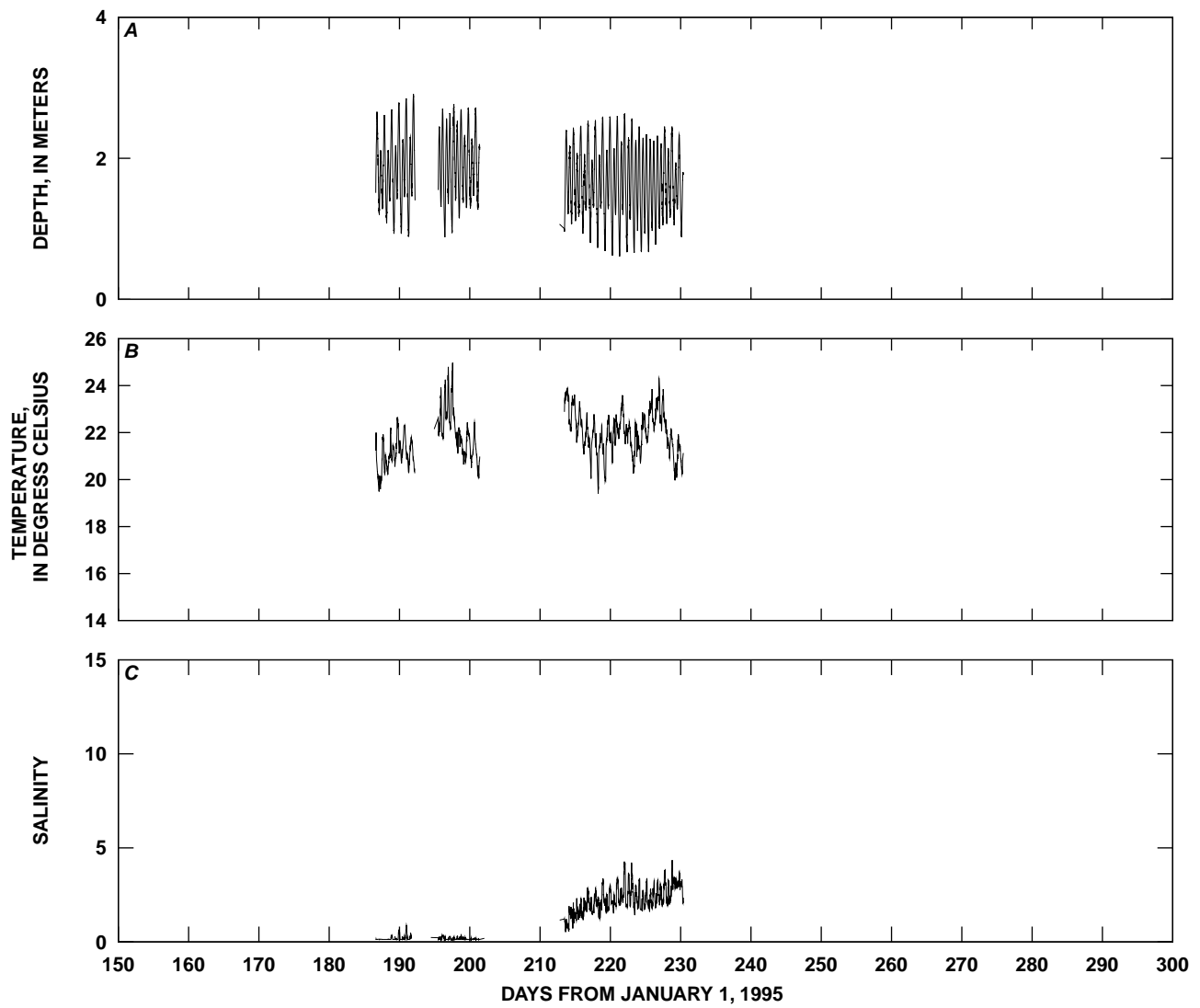

Figure 12. Time-series plots of *A*, depth; *B*, temperature; and *C*, salinity, Station GC, July 4 through August 18, 1995, Suisun Bay, California. Salinities in this report are presented without units because salinity is a conductivity ratio; therefore, it has no physical units (Millero, 1993).

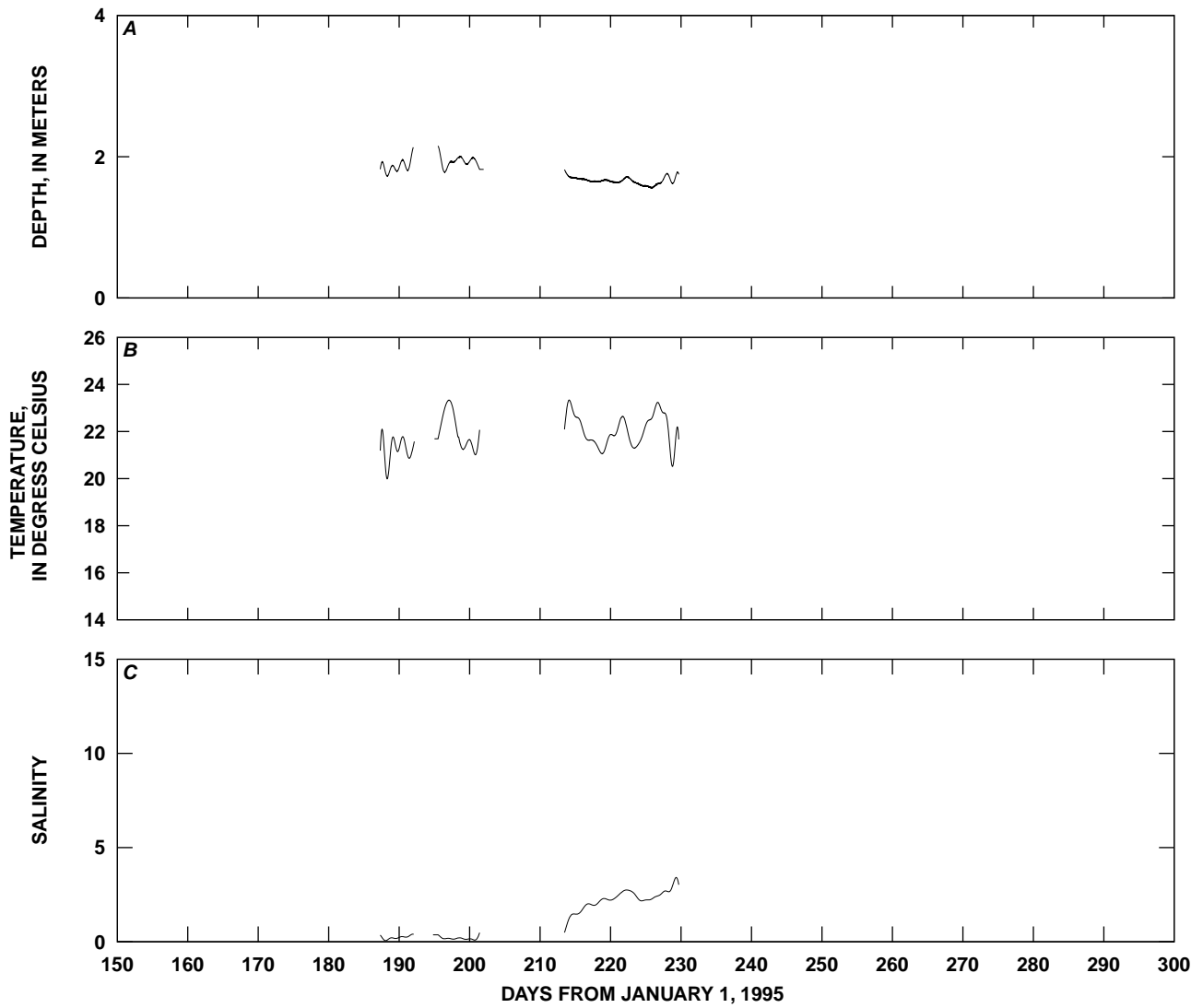

Figure 13. Time-series plots of low-pass-filtered *A*, depth; *B*, temperature; and *C*, salinity, Station GC, July 4 through August 18, 1995, Suisun Bay, California. Salinities in this report are presented without units because salinity is a conductivity ratio; therefore, it has no physical units (Millero, 1993).

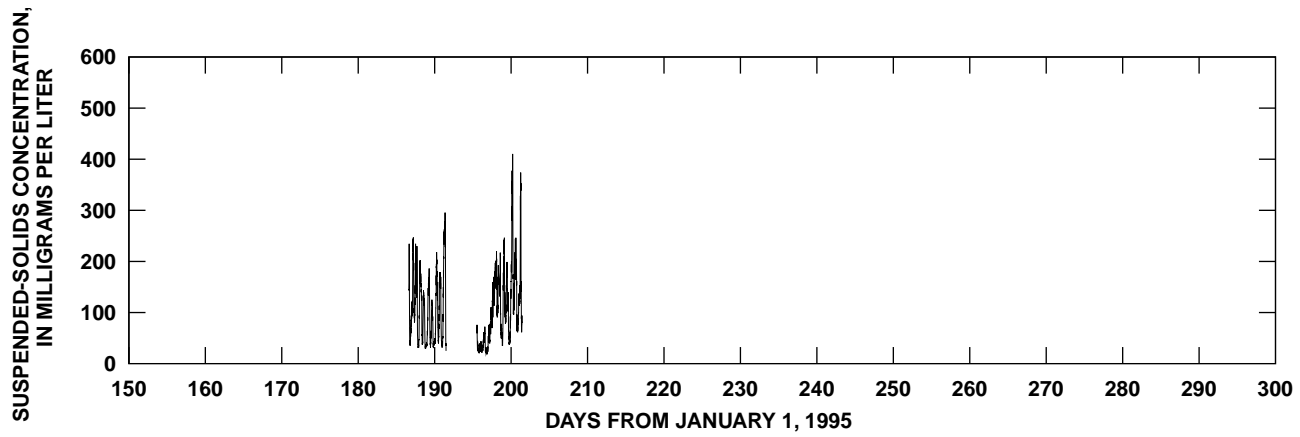

Figure 14. Time-series plot of suspended-solids concentration at Station GC, July 4 through August 18, 1995, Suisun Bay, California.

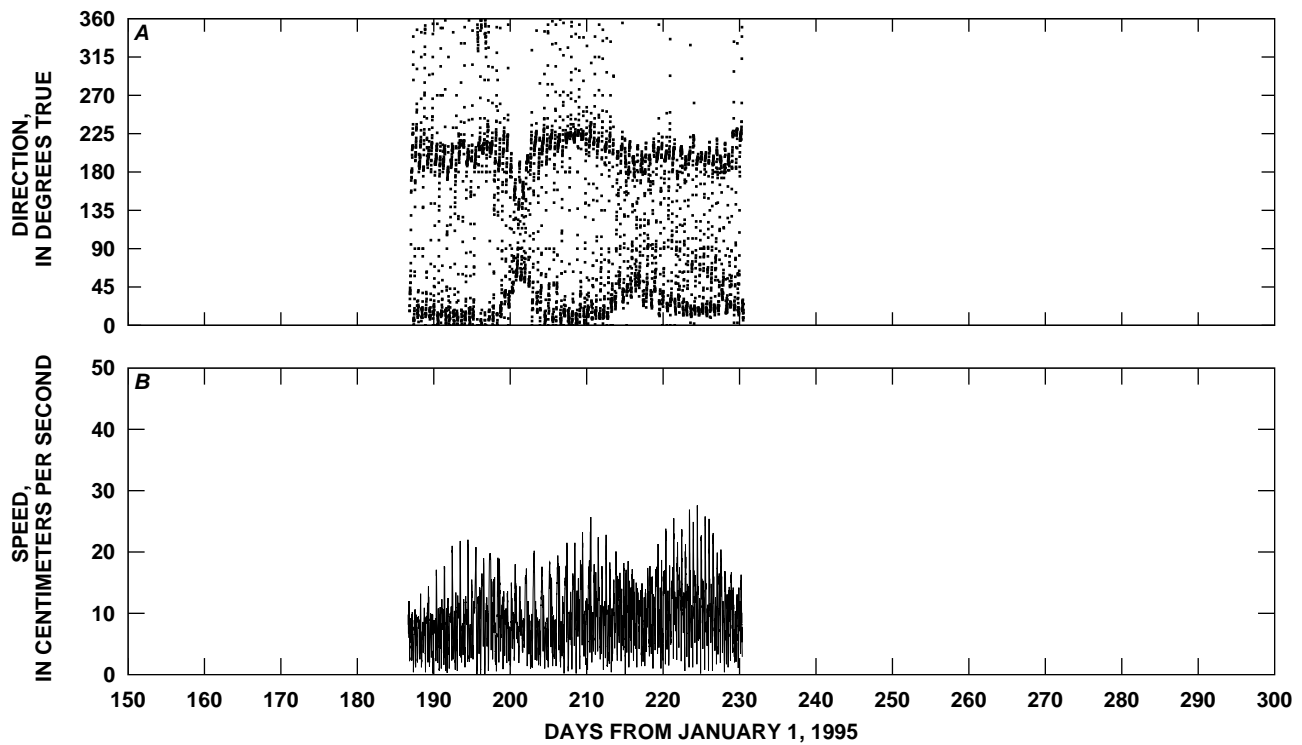

Figure 15. Time-series plots of tidal currents, Station GC, July 4 through August 18, 1995, Suisun Bay, California.

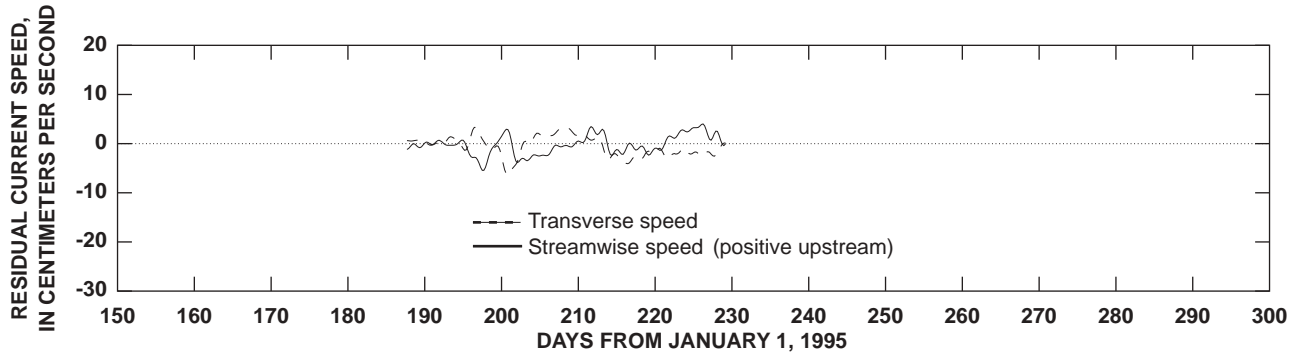

Figure 16. Longitudinal and transverse residual currents, Station GC, July 4 through August 18, 1995, Suisun Bay, California. Principal direction is 22.0 degrees true.

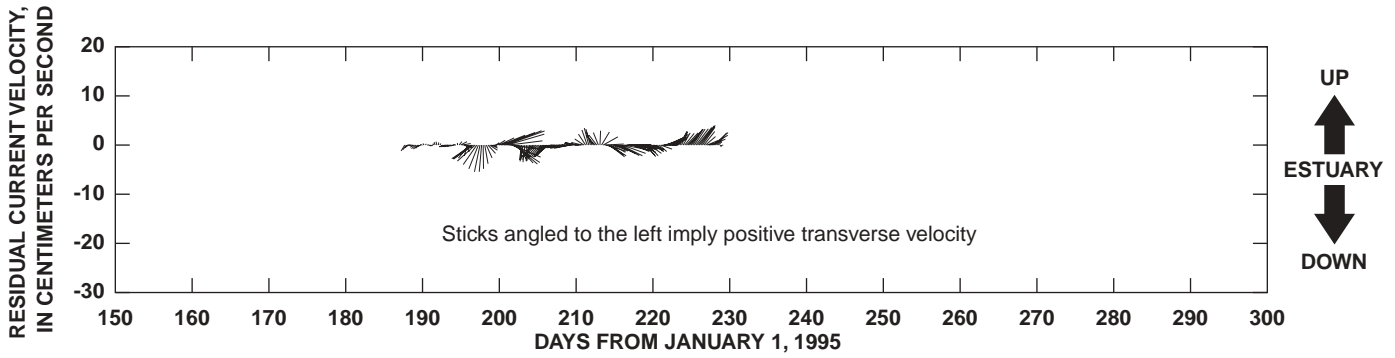

Figure 17. Residual currents, Station GC, July 4 through August 18, 1995, Suisun Bay, California. Principal direction is 22.0 degrees true.

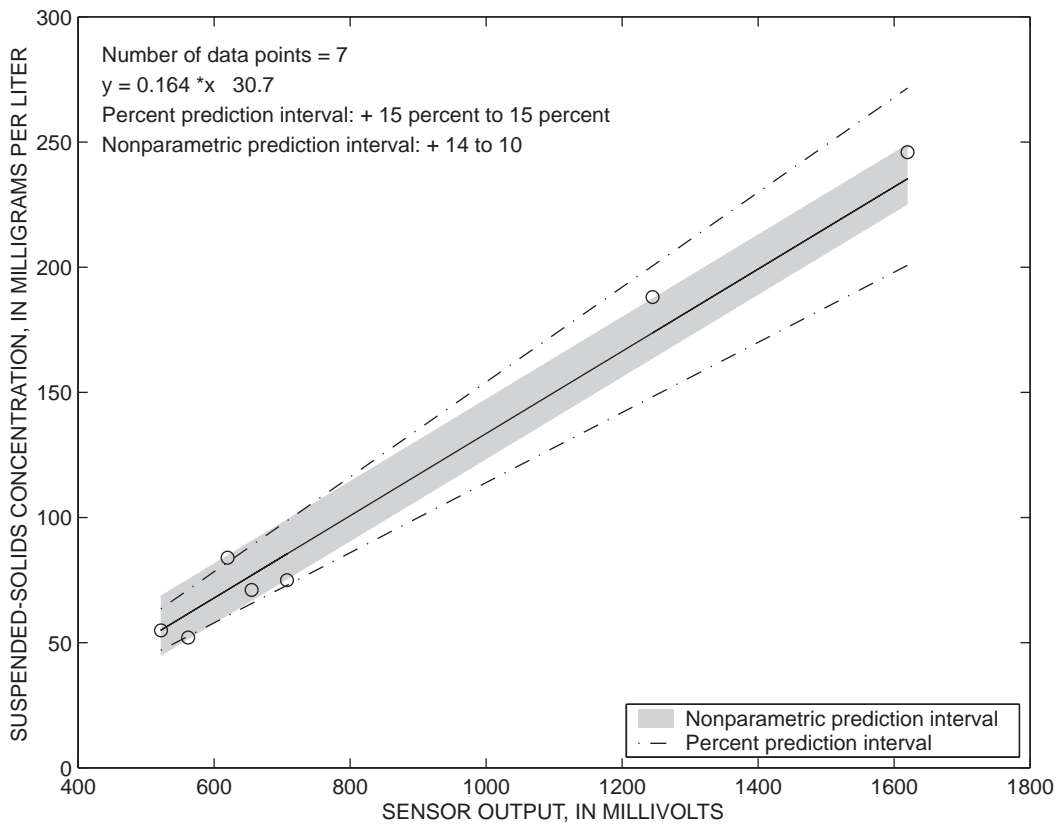

Figure 18. Calibration curve for near-bottom optical backscatterance sensor, Station GC, July 4 through August 18, 1995, Suisun Bay, California.

Table 11. Harmonic analysis results from depth measurements, Station GC, July 4 through August 18, 1995, Suisun Bay, California

Station: GC
Time series mean: 1.74757
Standard deviation: 0.14012
Harmonic constants: After tidal inference

Tidal symbol	Cycles (per day)	Mean amplitude (meters)	Local epoch (degrees)	Modified epoch (degrees)
Q1	0.89324	0.03844	124.40237	139.23920
O1	0.92954	0.19814	123.83319	134.31500
M1	0.96645	0.01407	123.25940	129.31195
P1	0.99726	0.09424	122.77170	125.12634
K1	1.00274	0.28471	122.68564	124.38321
Mu2	1.86455	0.01207	297.89734	318.20389
N2	1.89598	0.02384	55.55090	72.08527
Nu2	1.90084	0.00462	47.94794	63.89948
M2	1.93227	0.50293	358.81238	10.99176
L2	1.96857	0.01408	302.07385	309.89825
S2	2.00000	0.12362	59.72741	63.77961
K2	2.00548	0.03362	64.66152	68.05665
M4	3.86455	0.02986	282.91504	307.27377
Mk3	2.93501	0.03335	42.76810	56.64502

Table 12. Harmonic analysis results for velocity, Station GC, July 4 through August 18, 1995, Suisun Bay, California
[cm/s, centimeters per second; deg.T, degrees true; deg, degrees; E, equilibrium argument]

Station: GC
Start time of the series (local): Year, 95; Month, 8; Day, 4; Hour, 0: 5
Record length: 42 M2 Cycle: 4175 dat points

Tidal Symbol	Major axis (cm/s)	Minor axis (cm/s)	Direction (deg. T)	Phase (deg)	E (deg)	Rotation
O1	2.06	0.48	25.7	234.4	23.5	Clockwise
K1	3.68	0.60	29.2	232.4	210.4	Clockwise
N2	1.32	0.39	176.0	116.1	343.9	Counterclockwise
M2	10.48	2.02	21.3	297.2	233.7	Clockwise
S2	2.42	0.10	11.2	255.7	2.7	Clockwise
M4	1.52	0.38	25.2	195.6	107.4	Counterclockwise

Rootmeansquare speed, (cm/s): 9.92
Standard deviation, U series (cm/s): 3.14
Standard deviation, V series (cm/s): 3.51
Tidal form number: 0.44
Spring tidal current maximum (cm/s): 18.63
Neap tidal current maximum (cm/s): 6.43
Principal current direction (deg. T): 22.01

APPENDIX J—STATION GDOL

Station Name: **GDOL**
 (Grizzly Bay at the dolphin)

Position: Lat. 38°07'01"

Long. 122°02'26"

Depth: 1.7 m (MLLW)

Manufacturer	Serial Number	Deployment Dates
CT: Seacat	NA	7/17/95(198) - 9/18/95(261)
CTD: Ocean Sensors	OS200 306	7/17/95(198) - 9/18/95(261)
V: InterOcean	S4 08782105	7/06/95(187) - 9/18/95(261)
OBS: D & A	OBS3 681	7/17/95(198) - 9/18/95(261)

187), 7/11/95(192), 7/17/95(198), 7/26/95(207), 8/3/95(215), 8/10/95(222), 9/18/95(261)

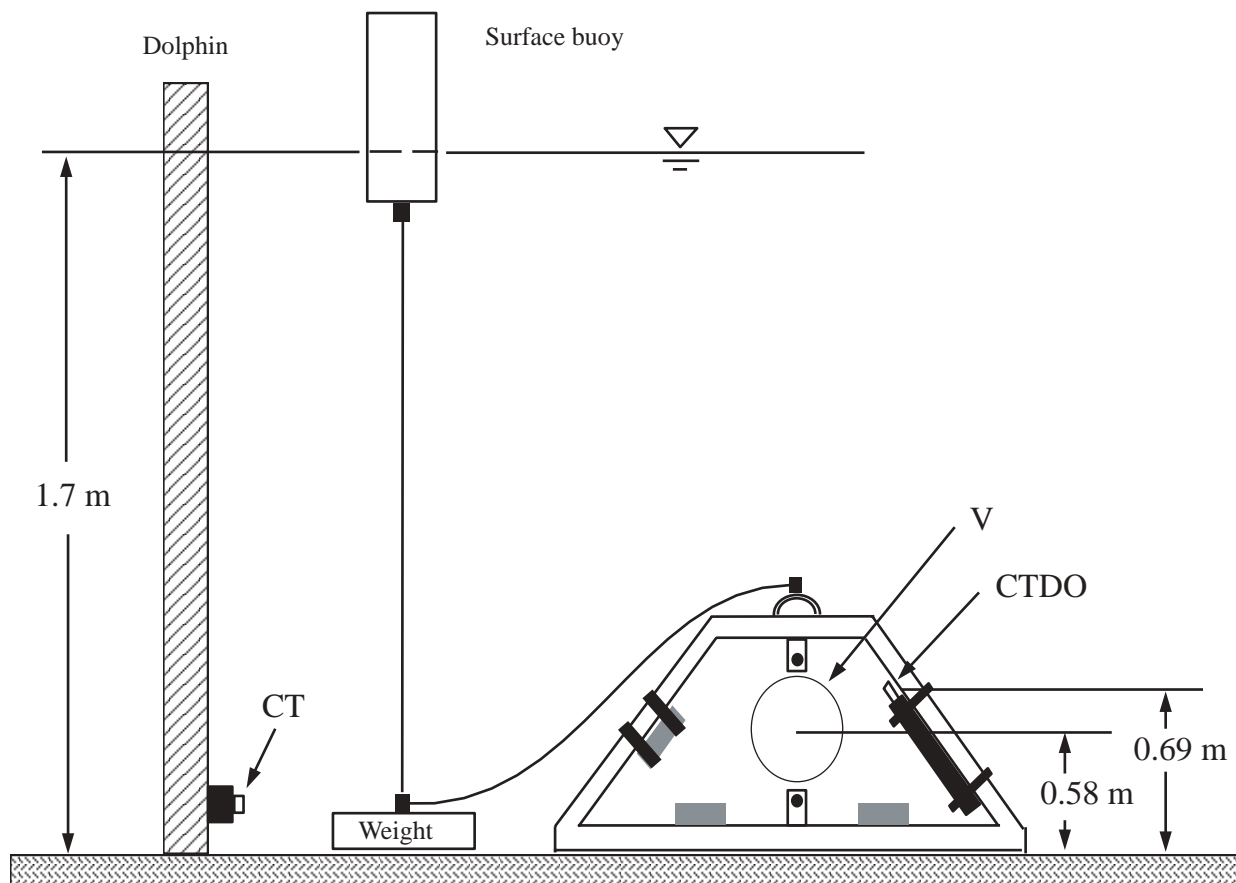

Figure J1. Configuration of instrument deployment, Station GDOL, July 6 through September 18, 1995, Suisun Bay, California. m, meters; MLLW, mean lower low water; OBS, optical backscatterance sensors; CT, conductivity-temperature; CTD, conductivity-temperature-depth; CTDO, conductivity-temperature-depth-optical (backscatterance sensor); V, velocity.

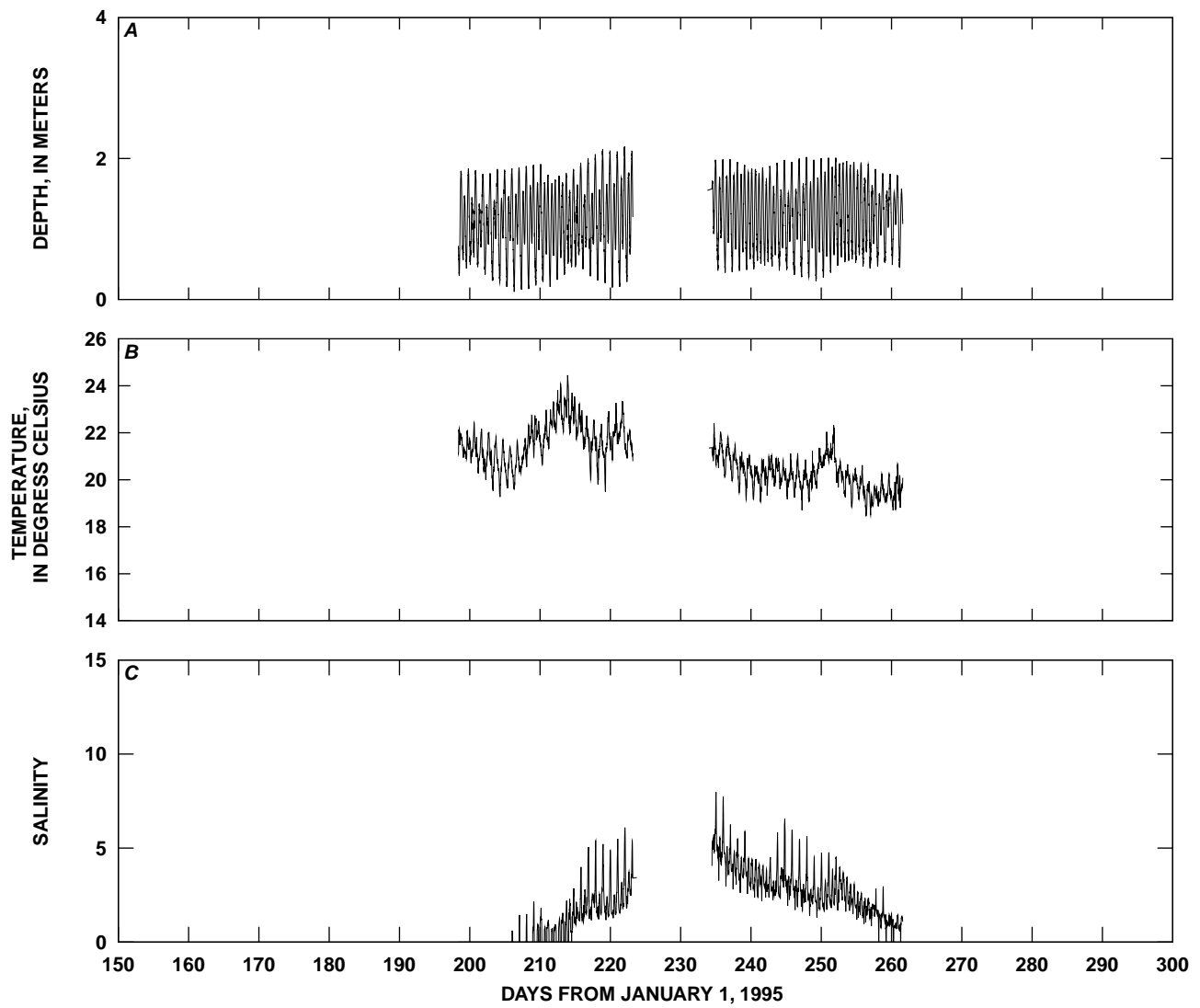

Figure J2. Time-series plots of *A*, depth; *B*, temperature; and *C*, salinity, Station GDOL, July 17 through September 18, 1995, Suisun Bay, California. Salinities in this report are presented without units because salinity is a conductivity ratio; therefore, it has no physical units (Millero, 1993).

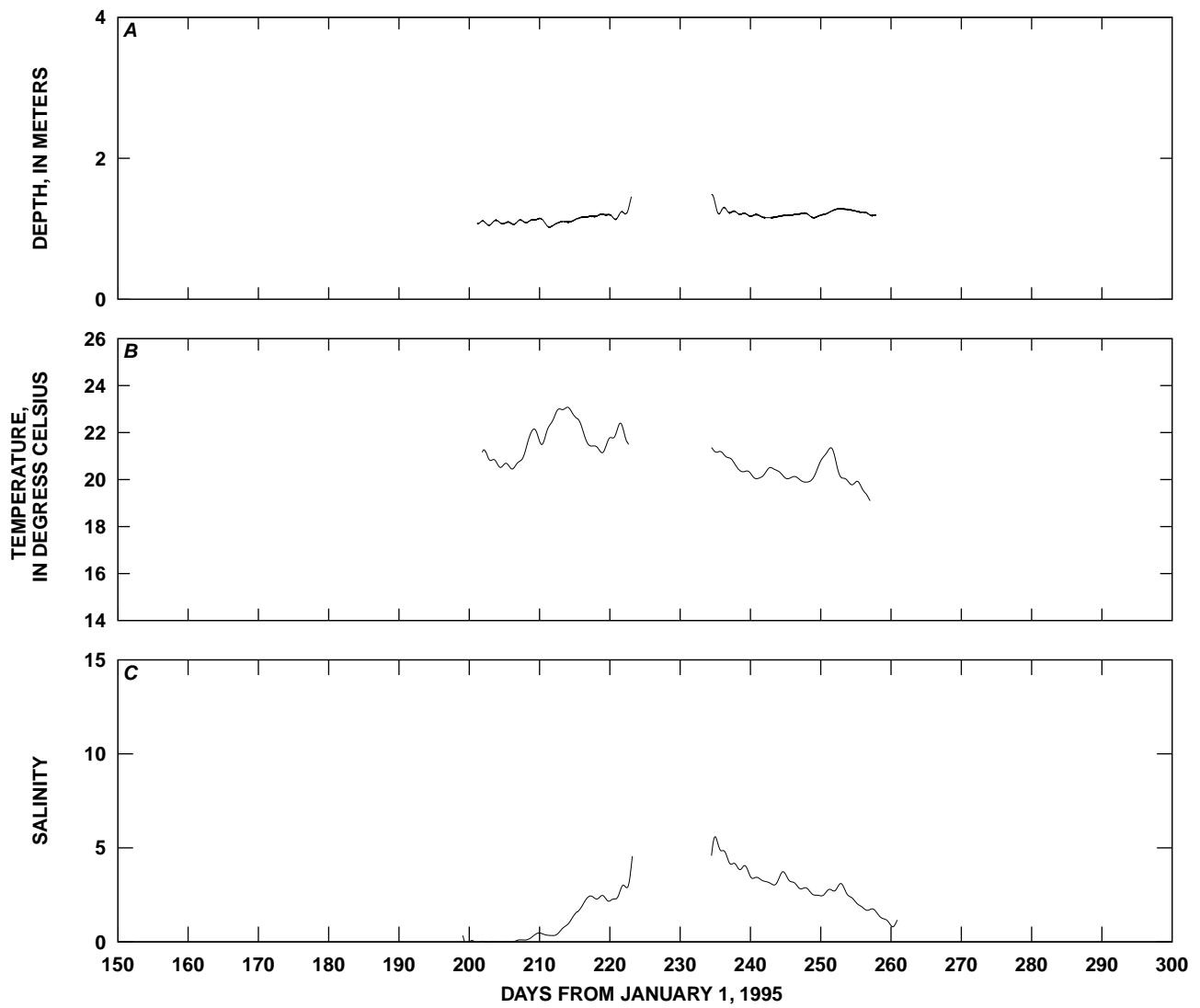

Figure J3. Time-series plots of low-pass-filtered *A*, depth; *B*, temperature; and *C*, salinity, Station GDOL, July 17 through September 18, 1995, Suisun Bay, California. Salinities in this report are presented without units because salinity is a conductivity ratio; therefore, it has no physical units (Millero, 1993).

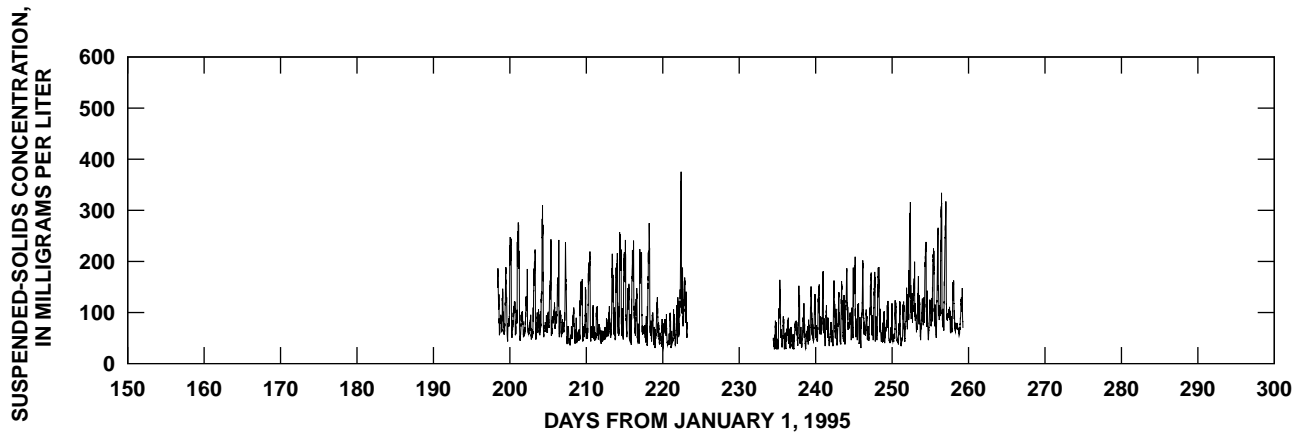

Figure J4. Time-series plot of suspended-solids concentration at Station GDOL, July 17 through September 18, 1995, Suisun Bay, California.

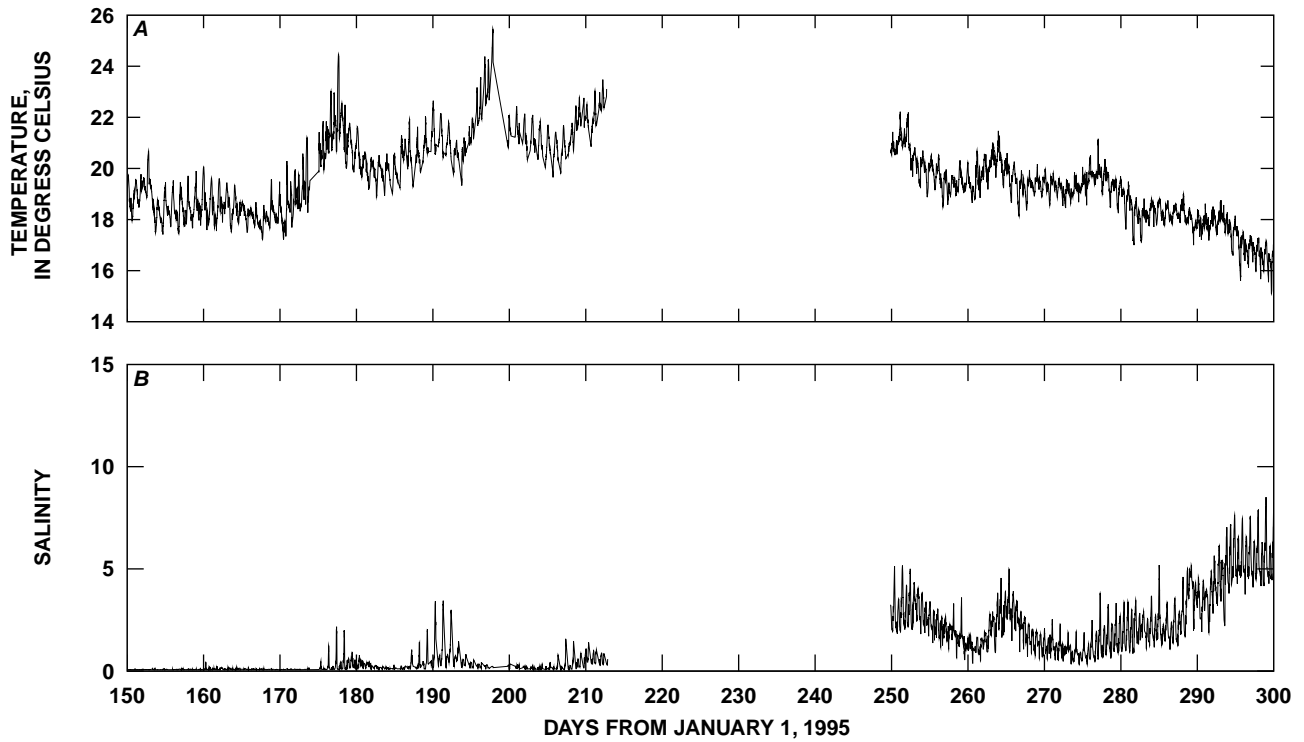

Figure J5. Time-series plots of *A*, temperature; and *B*, salinity, Station GDOL (collected by National Oceanic and Atmospheric Administration), April 30 through November 3, 1995, Suisun Bay, California. Salinities in this report are presented without units because salinity is a conductivity ratio; therefore, it has no physical units (Millero, 1993).

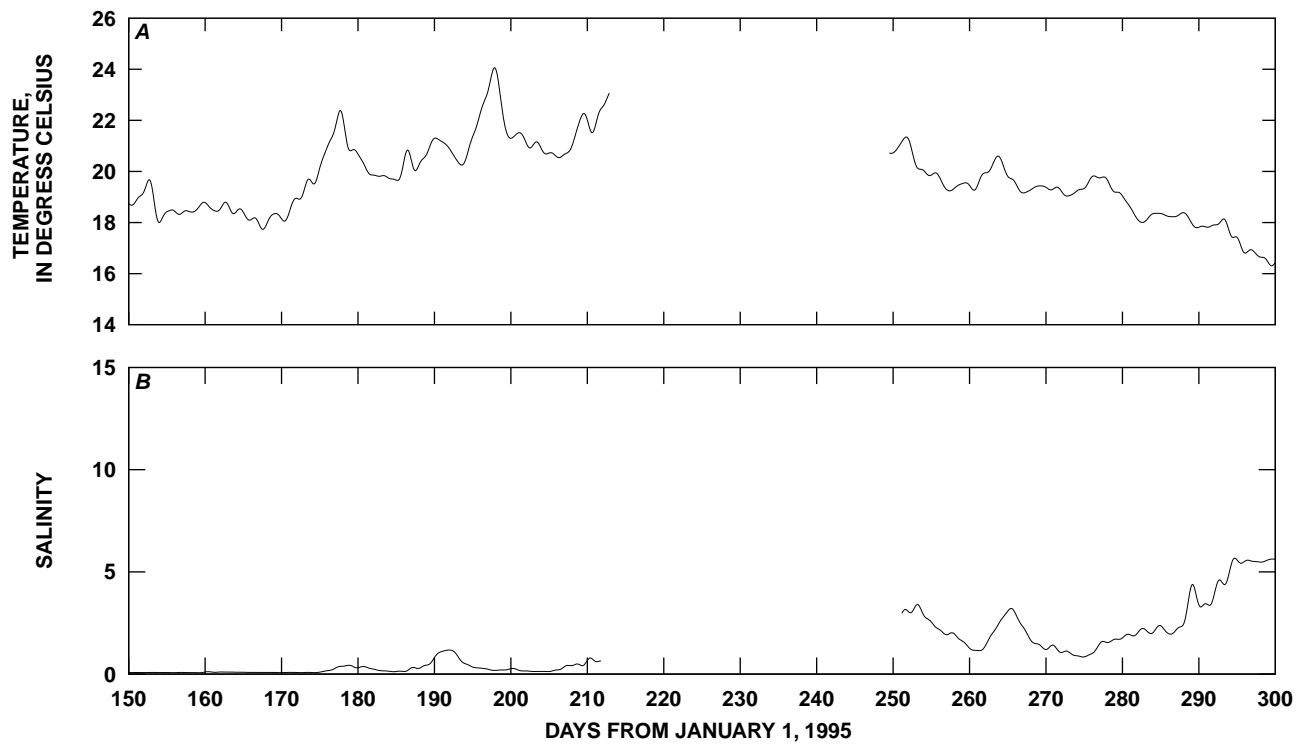

Figure J6. Time-series plots of low-pass-filtered *A*, temperature; and *B*, salinity, Station GDOL (collected by National Oceanic and Atmospheric Administration), April 30 through November 3, 1995, Suisun Bay, California. Salinities in this report are presented without units because salinity is a conductivity ratio; therefore, it has no physical units (Millero, 1993).

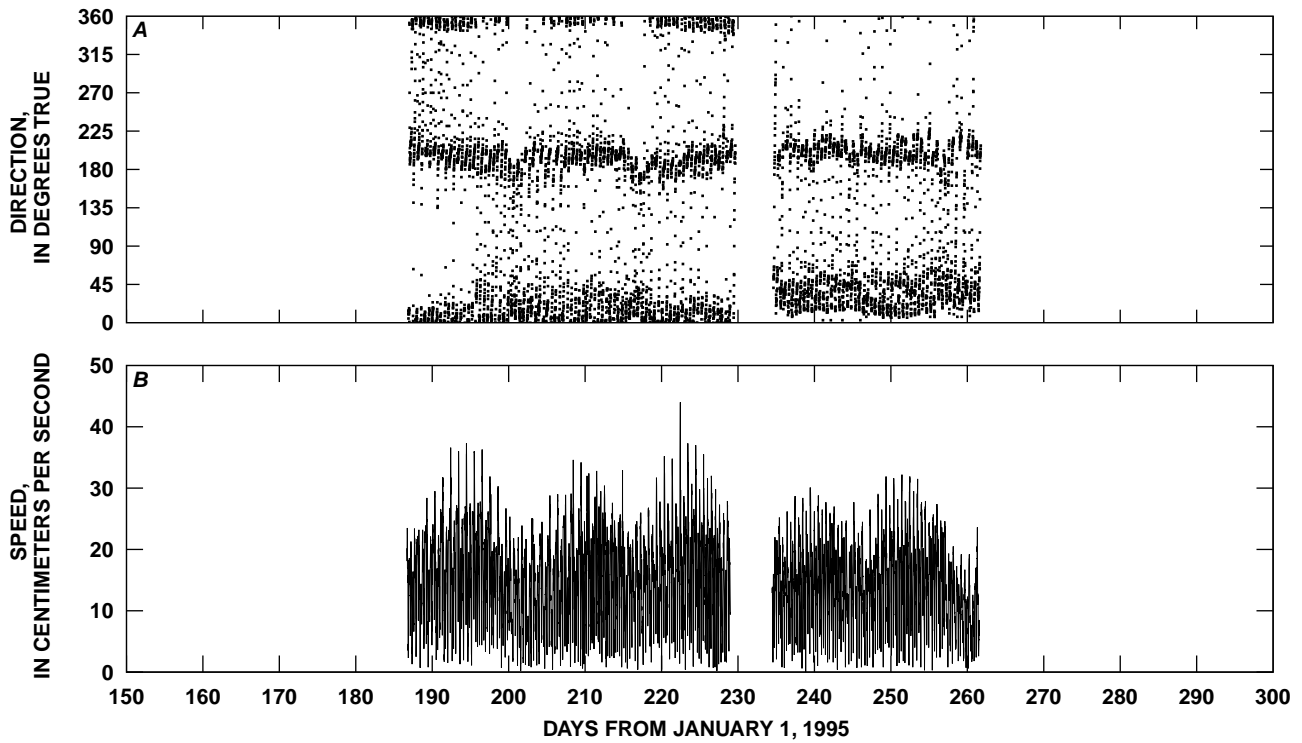

Figure J7. Time-series plots of tidal currents, Station GDOL, July 6 through September 18, 1995, Suisun Bay, California.

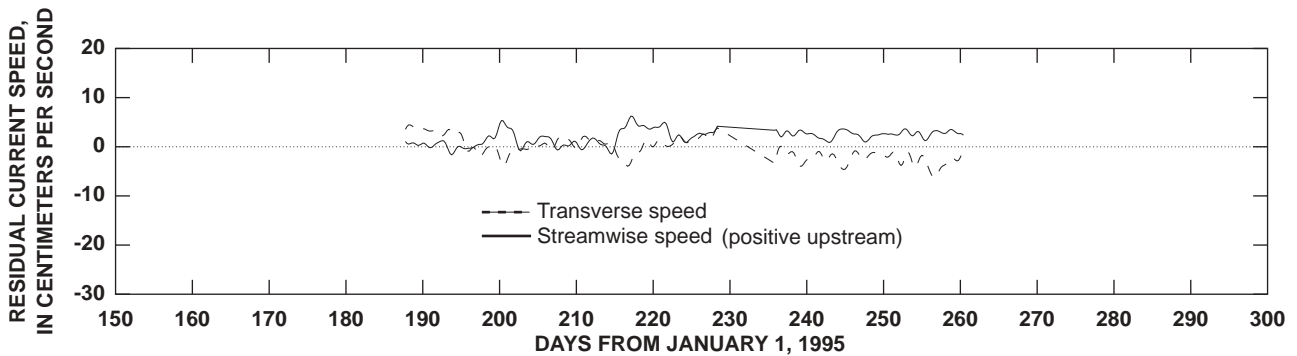

Figure J8. Longitudinal and transverse residual currents, Station GDOL, July 6 through September 18, 1995, Suisun Bay, California. Principal direction is 11.8 degrees true.

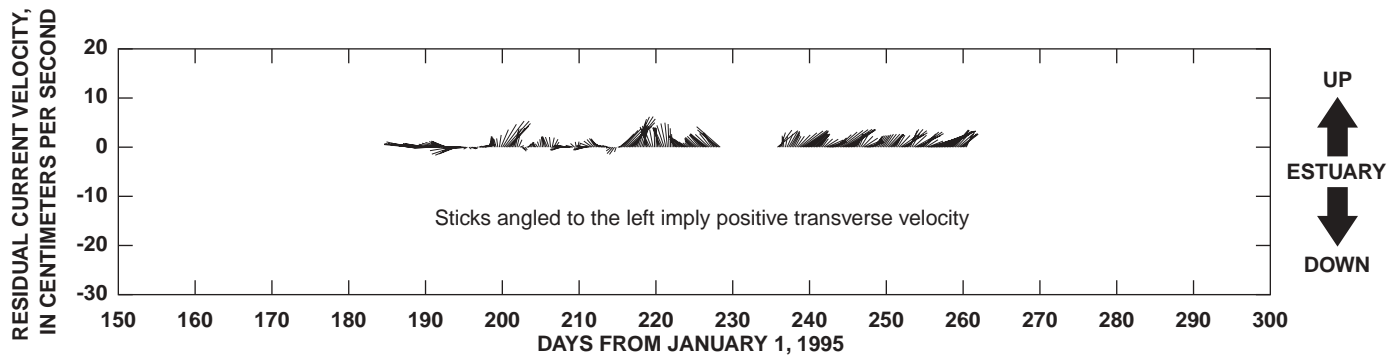

Figure J9. Residual currents, Station GDOL, July 6 through September 18, 1995, Suisun Bay, California. Principal direction is 11.8 degrees true.

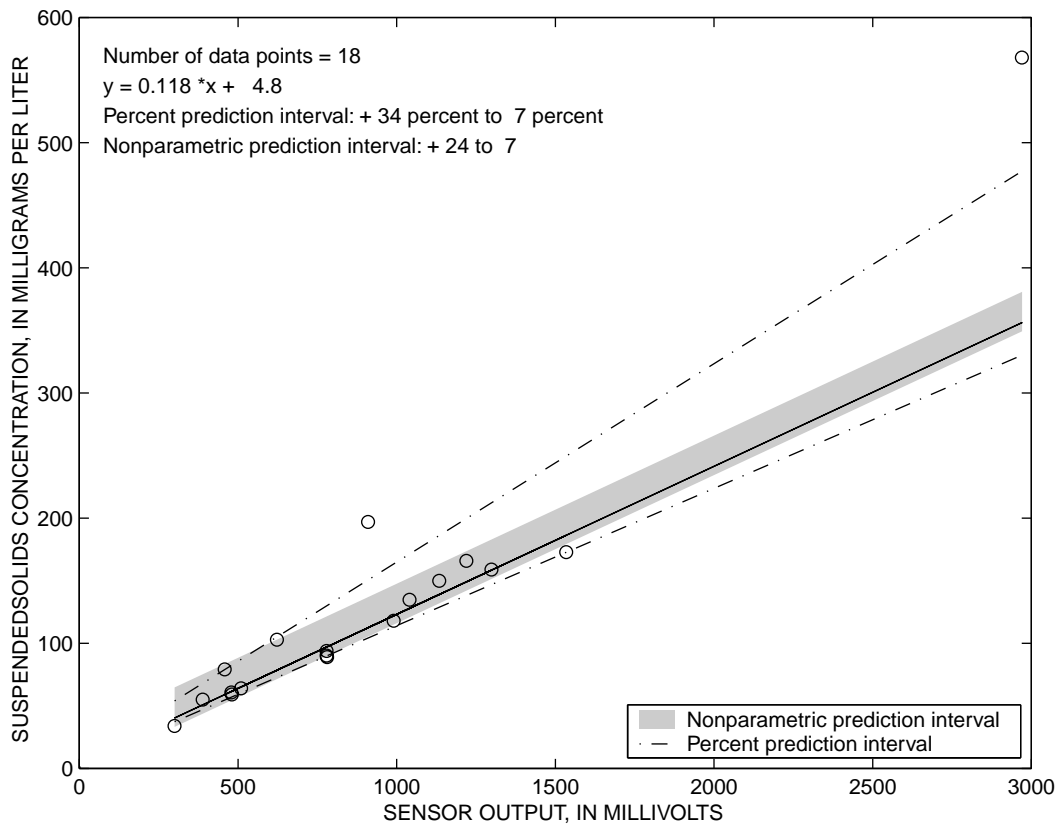

Figure J10. Calibration curve for near-bottom optical backscatterance sensor, Station GDOL, July 17 through September 18, 1995, Suisun Bay, California.

Table J1. Harmonic analysis results from depth measurements, Station GDOL, July 17 through September 18, 1995, Suisun Bay, California

Station: GDOL

Time series mean: 1.17272

Standard deviation: 0.10201

Harmonic constants: After tidal inference

Tidal symbol	Cycles (per day)	Mean amplitude (meters)	Local epoch (degrees)	Modified epoch (degrees)
Q1	0.89324	0.03816	106.71735	121.56860
O1	0.92954	0.19671	110.32547	120.82175
M1	0.96645	0.01397	113.96271	120.02972
P1	0.99726	0.09306	117.05432	119.42340
K1	1.00274	0.28114	117.59991	119.31192
Mu2	1.86455	0.01351	316.84509	337.18054
N2	1.89598	0.12963	15.80200	32.36530
Nu2	1.90084	0.02515	12.19940	28.17987
M2	1.93227	0.56295	348.91711	1.12543
L2	1.96857	0.01576	322.03223	329.88550
S2	2.00000	0.18755	20.98914	25.07025
K2	2.00548	0.05101	23.58698	27.01099
M4	3.86455	0.01582	252.44177	276.85831
Mk3	2.93501	0.03680	49.45427	63.37456

Table J2. Harmonic analysis results for velocity, Station GDOL, July 6 through September 18, 1995, Suisun Bay, California

[cm/s, centimeters per second; deg.T, degrees true; deg, degrees; E, equilibrium argument]

Station: GDOL

Start time of the series (local): Year, 95; Month, 8; Day, 3; Hour, 0: 3

Record length: 68 M2 Cycle: 6697 data points

Tidal Symbol	Major axis (cm/s)	Minor axis (cm/s)	Direction (deg. T)	Phase (deg)	E (deg)	Rotation
O1	4.07	0.48	22.4	185.3	332.3	Clockwise
K1	7.56	0.84	15.6	218.2	211.9	Clockwise
N2	3.94	0.89	12.0	213.9	268.1	Clockwise
M2	19.67	2.91	9.3	215.3	184.1	Clockwise
S2	4.30	1.10	6.5	233.7	1.8	Clockwise
M4	1.29	0.46	176.2	188.5	8.2	Counterclockwise

Rootmeansquare speed, (cm/s): 17.34

Standard deviation, U series (cm/s): 3.38

Standard deviation, V series (cm/s): 4.94

Tidal form number: 0.48

Spring tidal current maximum (cm/s): 35.60

Neap tidal current maximum (cm/s): 11.87

Principal current direction (deg. T): 11.77

THIS PAGE LEFT BLANK INTENTIONALLY

APPENDIX K—STATION GS

Station Name: GS
(Grizzly Bay East side)
Position: Lat. 38°06'28"
Long. 122°01'22"
Depth: 1.2 m (MLLW)

Manufacturer	Serial Number	Deployment Dates
CTD: Ocean Sensors	OS200 305	7/6/95(187) - 9/18/95(261)
V: InterOcean	S408782106	7/6/95(187) - 9/18/95(261)
OBS: D & A	OBS3 683	7/6/95(187) - 9/18/95(261)

Serviced: 7/6/95(187), 7/14/95(195), 7/20/95(201), 7/26/95(207), 8/2/95(214), 8/9/95(221), 8/12/95(224), 8/22/95(234), 9/18/95(261)

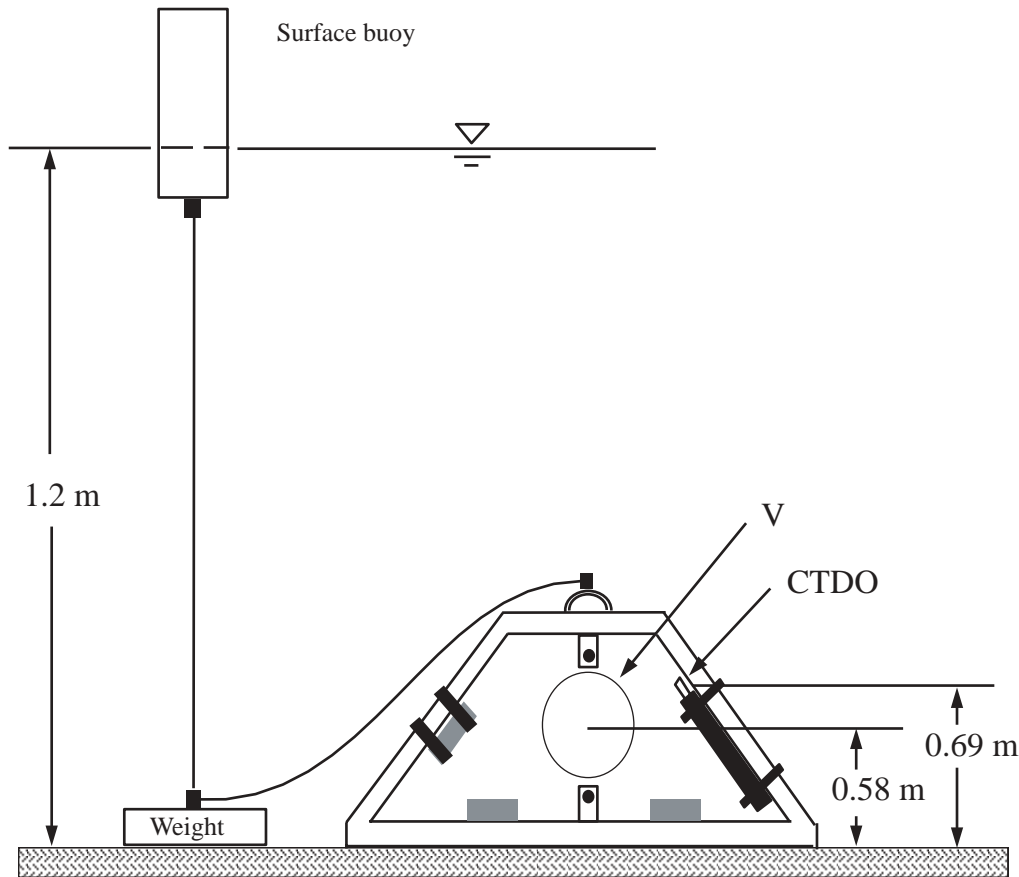

Figure K1. Configuration of instrument deployment, Station GS, July 6 through September 18, 1995, Suisun Bay, California. m, meters; MLLW, mean lower low water; OBS, optical backscatterance sensor; CTD, conductivity-temperature-depth; CTDO, conductivity-temperature-depth-optical (backscatterance sensor); V, velocity.

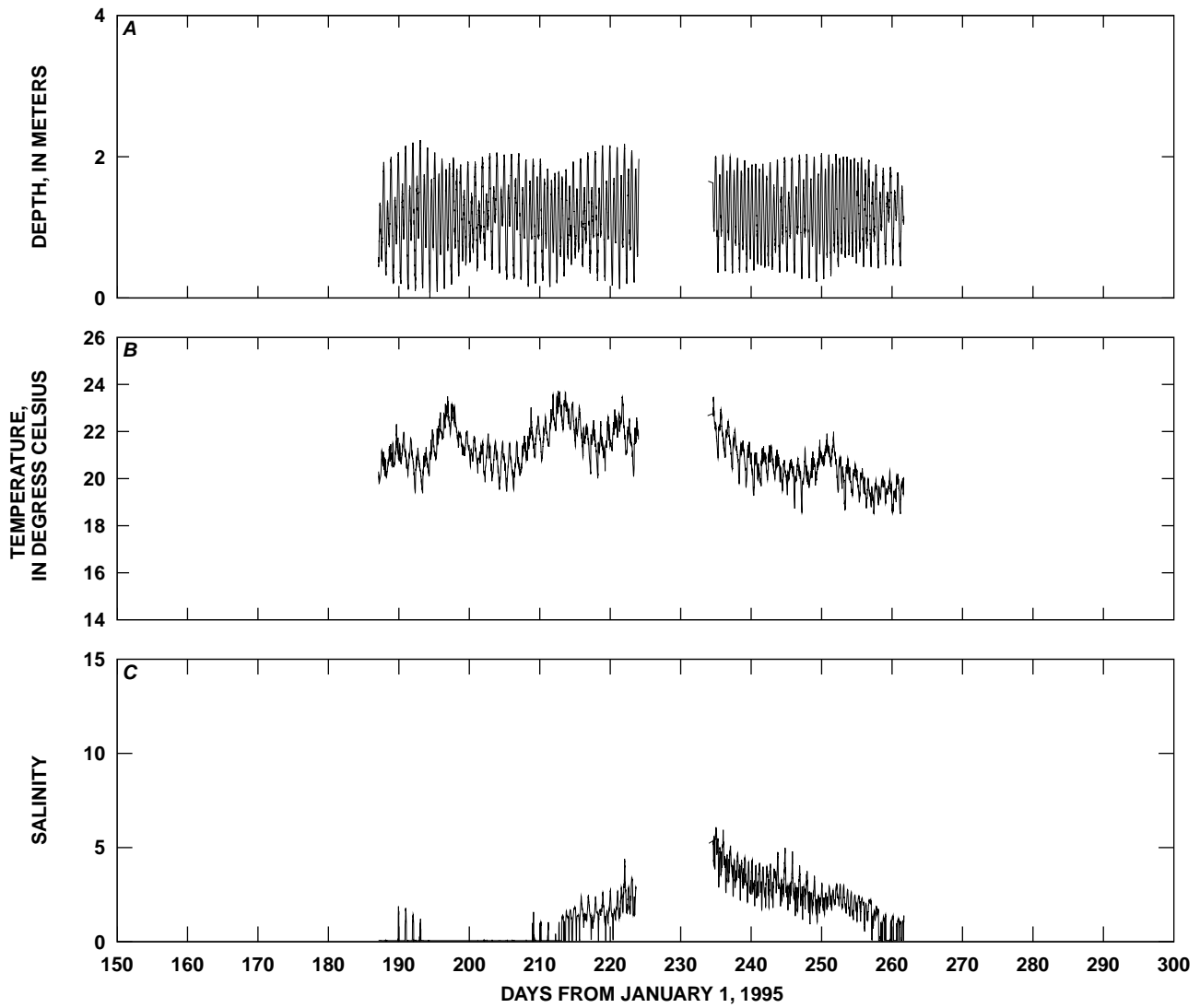

Figure K2. Time-series plots of *A*, depth; *B*, temperature; and *C*, salinity, Station GS, July 6 through September 18, 1995, Suisun Bay, California. Salinities in this report are presented without units because salinity is a conductivity ratio; therefore, it has no physical units (Millero, 1993).

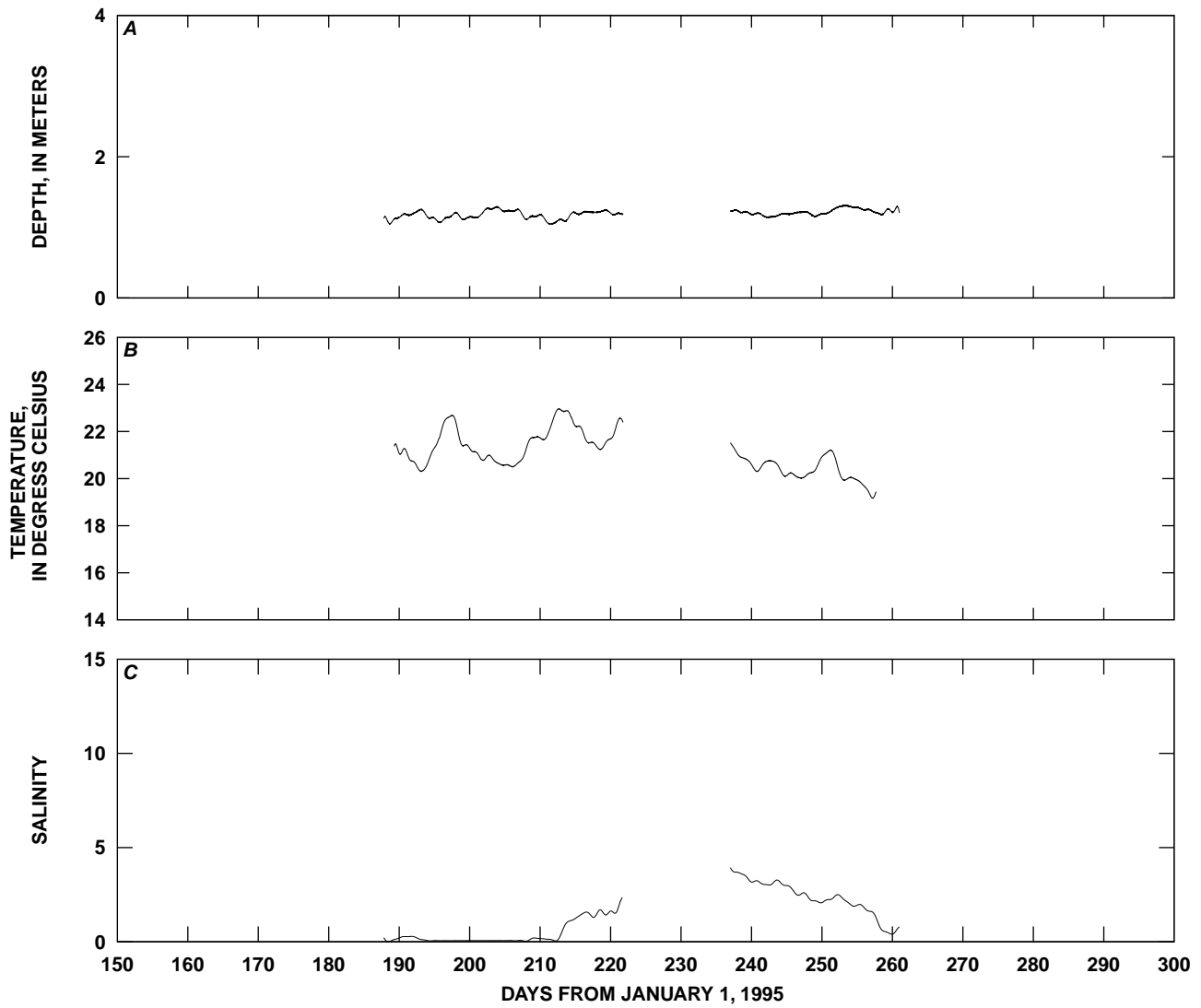

Figure K3. Time-series plots of low-pass-filtered *A*, depth; *B*, temperature; and *C*, salinity, Station GS, July 6 through September 18, 1995, Suisun Bay, California. Salinities in this report are presented without units because salinity is a conductivity ratio; therefore, it has no physical units (Millero, 1993).

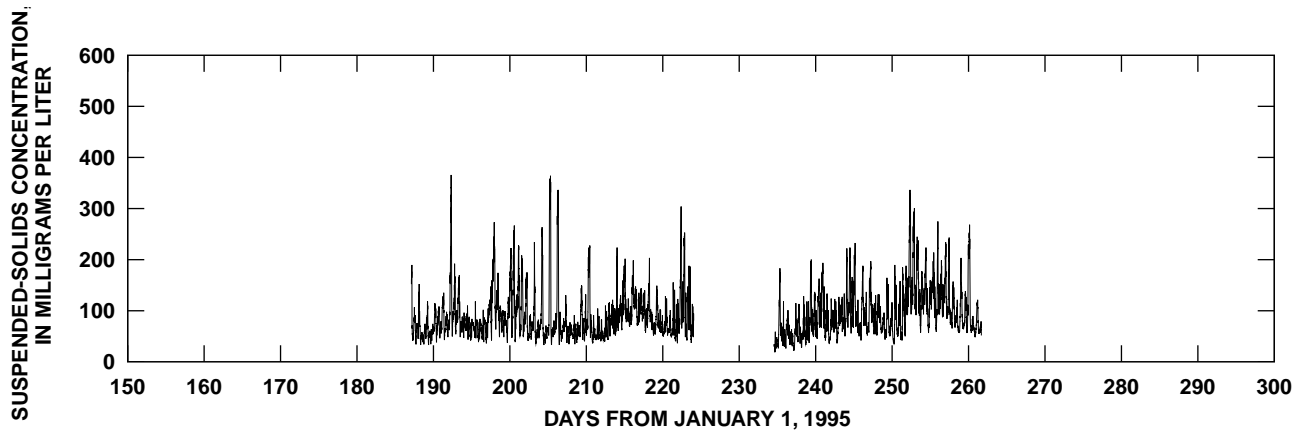

Figure K4. Time-series plot of suspended-solids concentration at Station GS, July 6 through September 18, 1995, Suisun Bay, California.

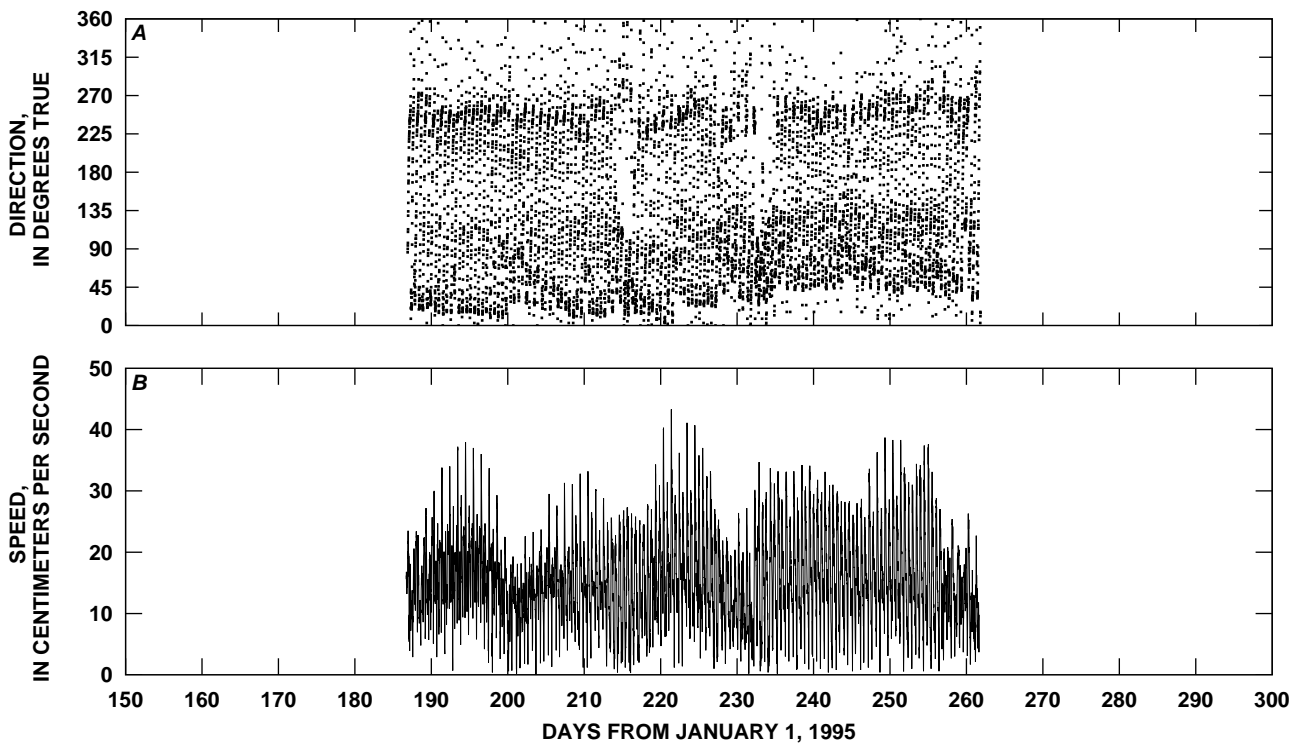

Figure K5. Time-series plots of tidal currents, Station GS, July 6 through September 18, 1995, Suisun Bay, California.

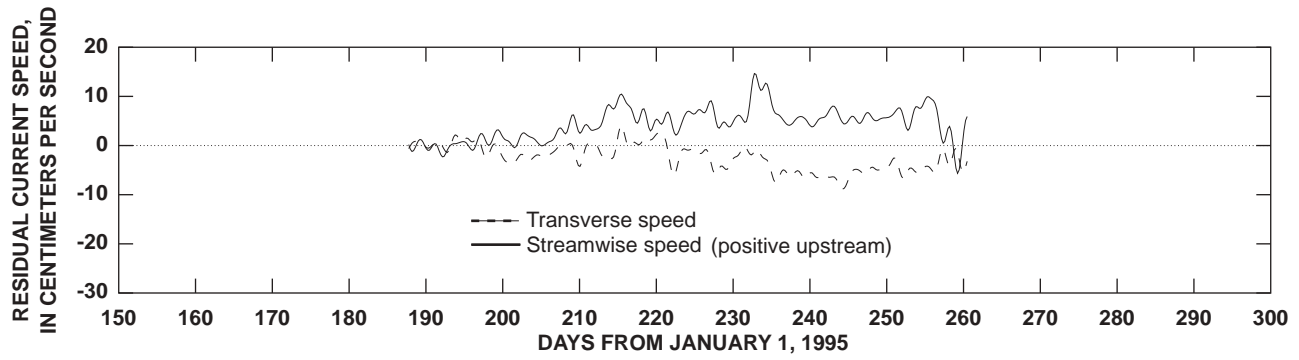

Figure K6. Longitudinal and transverse residual currents, Station GS, July 6 through September 18, 1995, Suisun Bay, California. Principal direction is 58.9 degrees true.

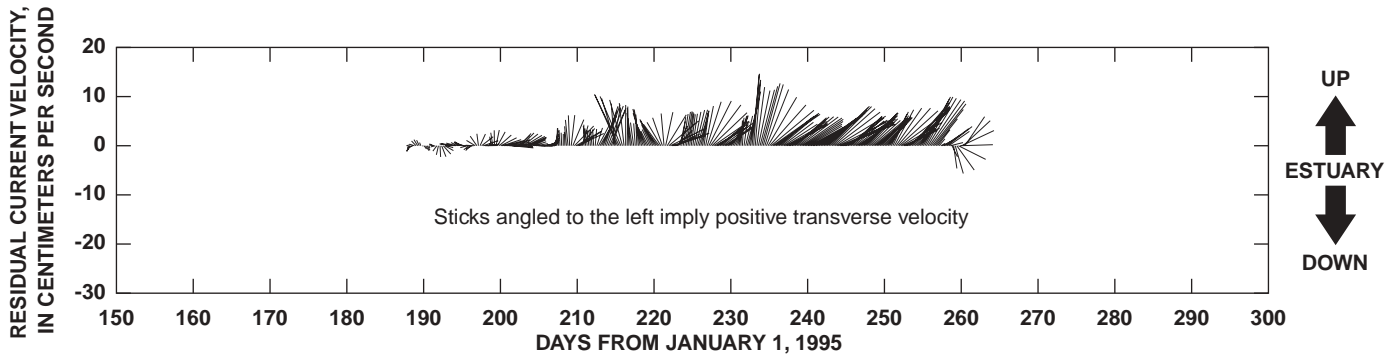

Figure K7. Residual currents, Station GS, July 6 through September 18, 1995, Suisun Bay, California. Principal direction is 58.9 degrees true.

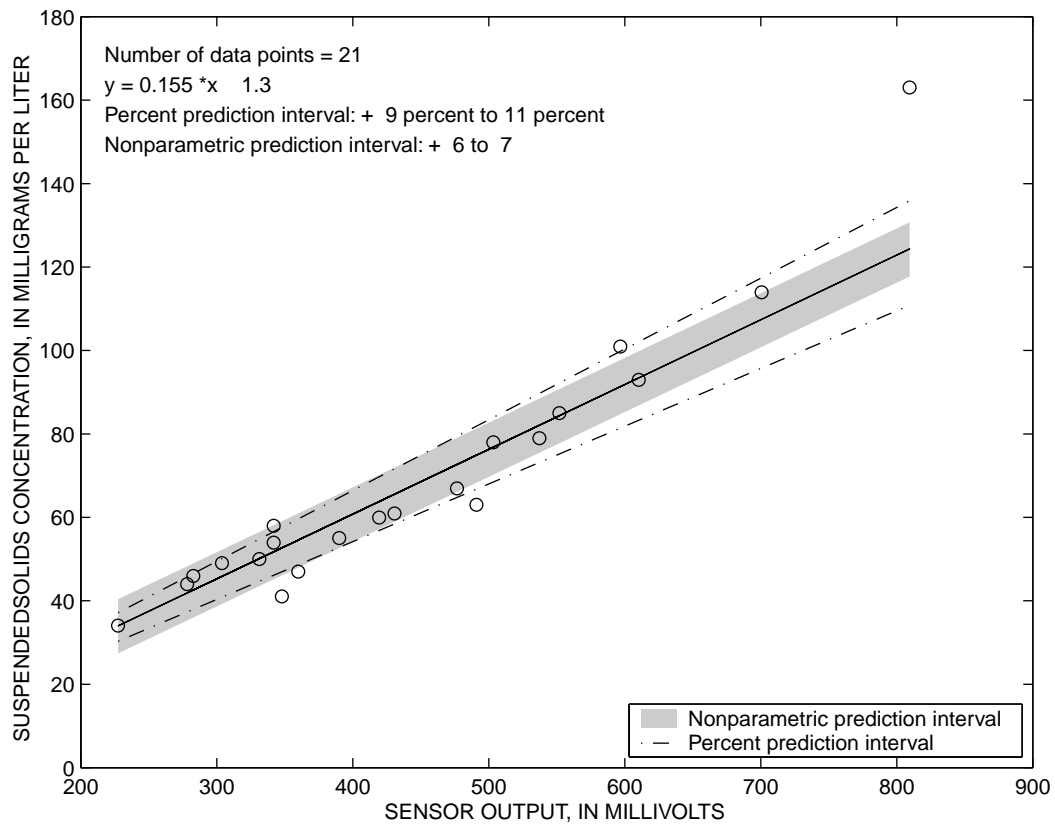

Figure K8. Calibration curve for near-bottom optical backscatterance sensor, Station GS, July 6 through September 18, 1995, Suisun Bay, California.

Table K1. Harmonic analysis results from depth measurements, Station GS, July 6 through September 18, 1995, Suisun Bay, California

Station: GS

Time series mean: 1.19368

Standard deviation: 0.10221

Harmonic constants: After tidal inference

Tidal symbol	Cycles (per day)	Mean amplitude (meters)	Local epoch (degrees)	Modified epoch (degrees)
Q1	0.89324	0.03647	129.36859	144.20209
O1	0.92954	0.18798	131.93564	142.41412
M1	0.96645	0.01335	134.52338	140.57260
P1	0.99726	0.09449	136.72299	139.07431
K1	1.00274	0.28548	137.11115	138.80539
Mu2	1.86455	0.01275	339.22406	359.52396
N2	1.89598	0.06253	56.15903	72.68675
Nu2	1.90084	0.01213	51.72733	67.67224
M2	1.93227	0.53117	23.08667	35.25940
L2	1.96857	0.01487	350.01431	357.83203
S2	2.00000	0.14941	66.94928	70.99481
K2	2.00548	0.04064	70.50214	73.89063
M4	3.86455	0.03203	331.49387	355.83929
Mk3	2.93501	0.03974	103.98887	117.85584

Table K2. Harmonic analysis results for velocity, Station GS, July 6 through September 18, 1995, Suisun Bay, California

[cm/s, centimeters per second; deg.T, degrees true; deg, degrees; E, equilibrium argument]

Station: GS

Start time of the series (local): Year, 0; Month, 0; Day, 0; Hour, 0: 0

Record length: 73 M2 Cycle: 7196 data points

Tidal Symbol	Major axis (cm/s)	Minor axis (cm/s)	Direction (deg. T)	Phase (deg)	E (deg)	Rotation
O1	2.88	0.92	73.1	229.6	25.4	Clockwise
K1	3.90	2.03	69.5	351.8	359.0	Clockwise
N2	3.06	1.20	48.8	312.6	37.4	Clockwise
M2	16.23	7.76	56.8	32.4	24.4	Clockwise
S2	4.27	2.14	47.8	184.2	0.0	Clockwise
M4	3.26	0.35	171.6	218.2	48.8	Counterclockwise

Rootmeansquare speed, (cm/s): 17.17

Standard deviation, U series (cm/s): 5.55

Standard deviation, V series (cm/s): 5.95

Tidal form number: 0.33

Spring tidal current maximum (cm/s): 27.27

Neap tidal current maximum (cm/s): 10.95

Principal current direction (deg. T): 58.92

APPENDIX L—STATION HC

Station Name: **HC**
 (Honker Bay center)
 Position: Lat. 38° 04'26"
 Long. 121°55'45"
 Depth: 0.9 m (MLLW)

<i>Manufacturer</i>	<i>Serial Number</i>	<i>Deployment Dates</i>
CTD: Ocean Sensors	OS200 303	7/28/95(209) - 10/24/95(297)
V: InterOcean	S408782108	7/9/95(190) - 10/24/95(297)
OBS: D & A	OBS3 679	7/28/95(209) - 10/24/95(297)

Serviced: 7/9/95(190), 7/28/95(209), 8/2/95(214), 8/10/95(222), 8/23/95(235), 9/18/95(261), 10/24/95(297)

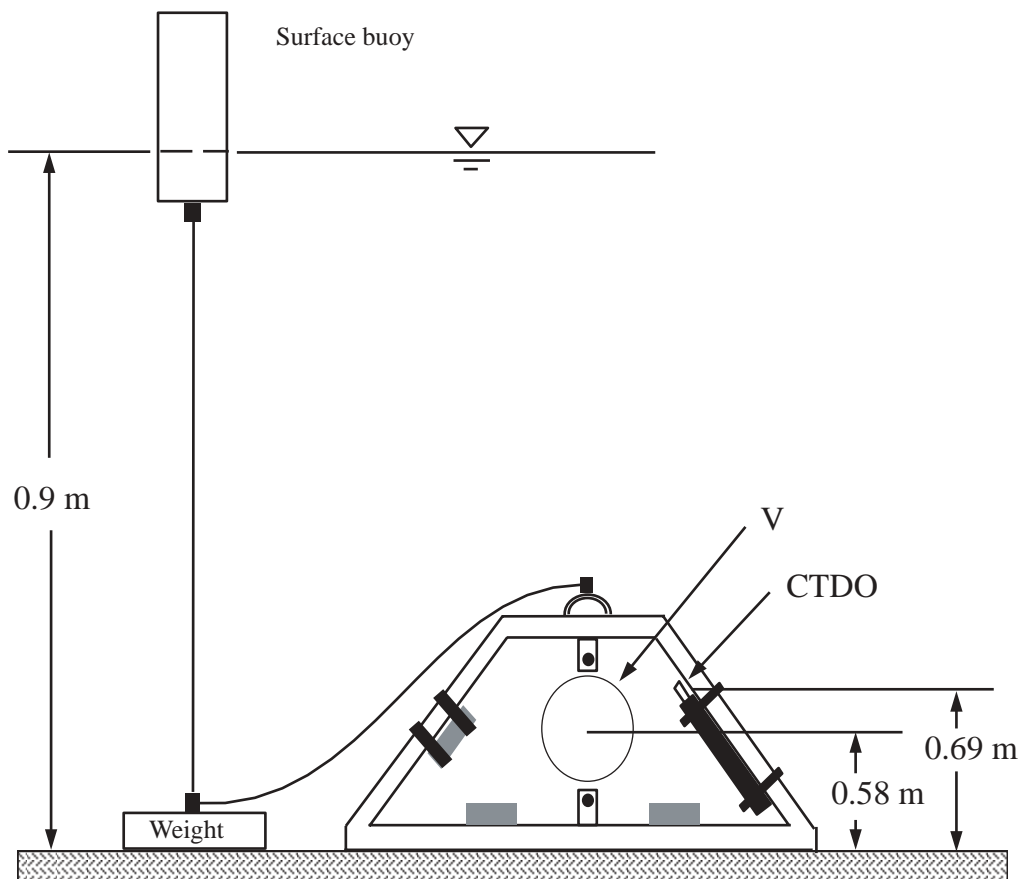

Figure L1. Configuration of instrument deployment, Station HC, July 9 through October 24, 1995, Suisun Bay, California. m, meters; MLLW, mean lower low water; OBS, optical backscatterance sensor; CTD, conductivity-temperature-depth; CTDO, conductivity-temperature-depth-optical (backscatterance sensor); V, velocity.

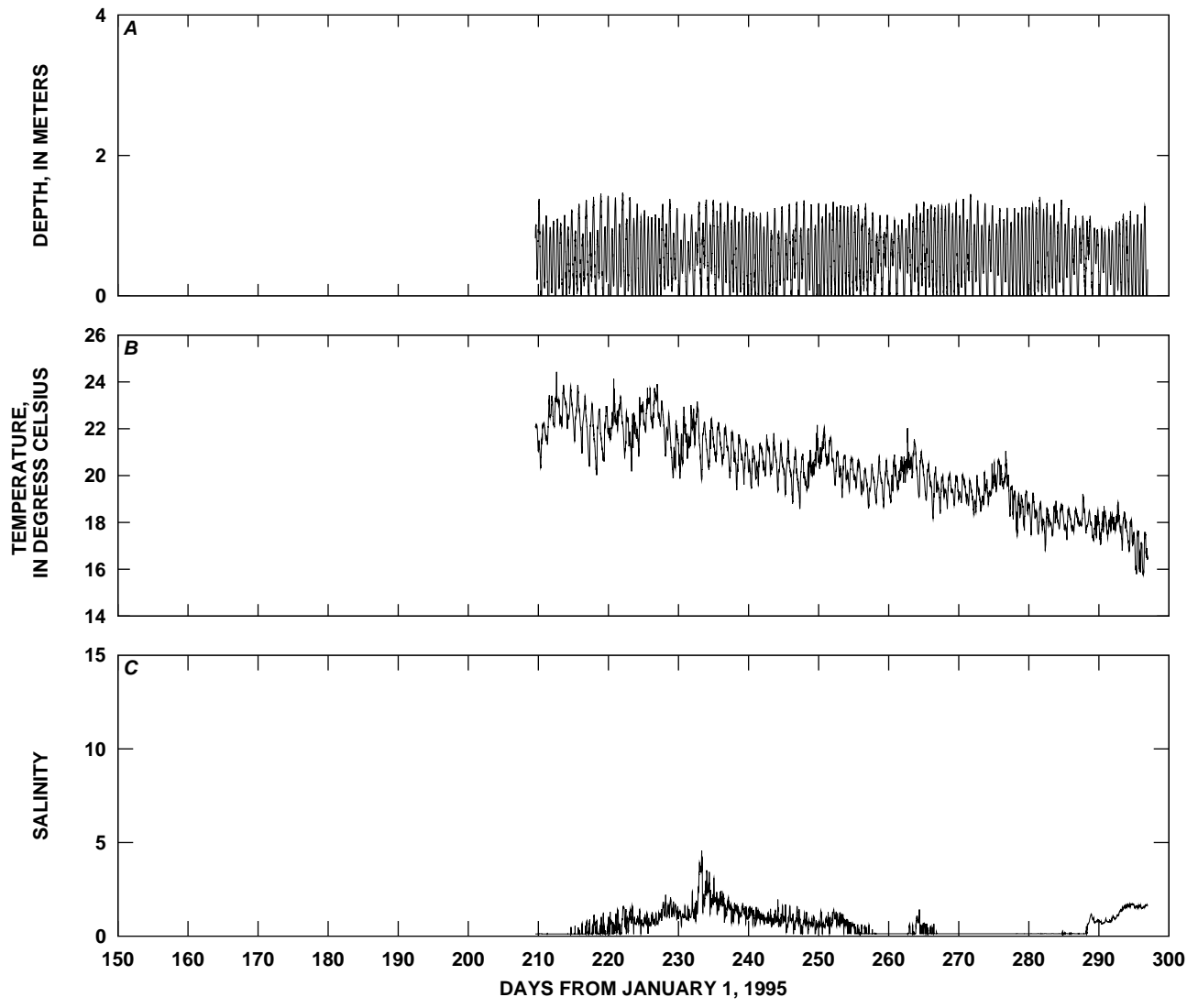

Figure L2. Time-series plots of *A*, depth; *B*, temperature; and *C*, salinity, Station HC, July 28 through October 24, 1995, Suisun Bay, California. Salinities in this report are presented without units because salinity is a conductivity ratio; therefore, it has no physical units (Millero, 1993).

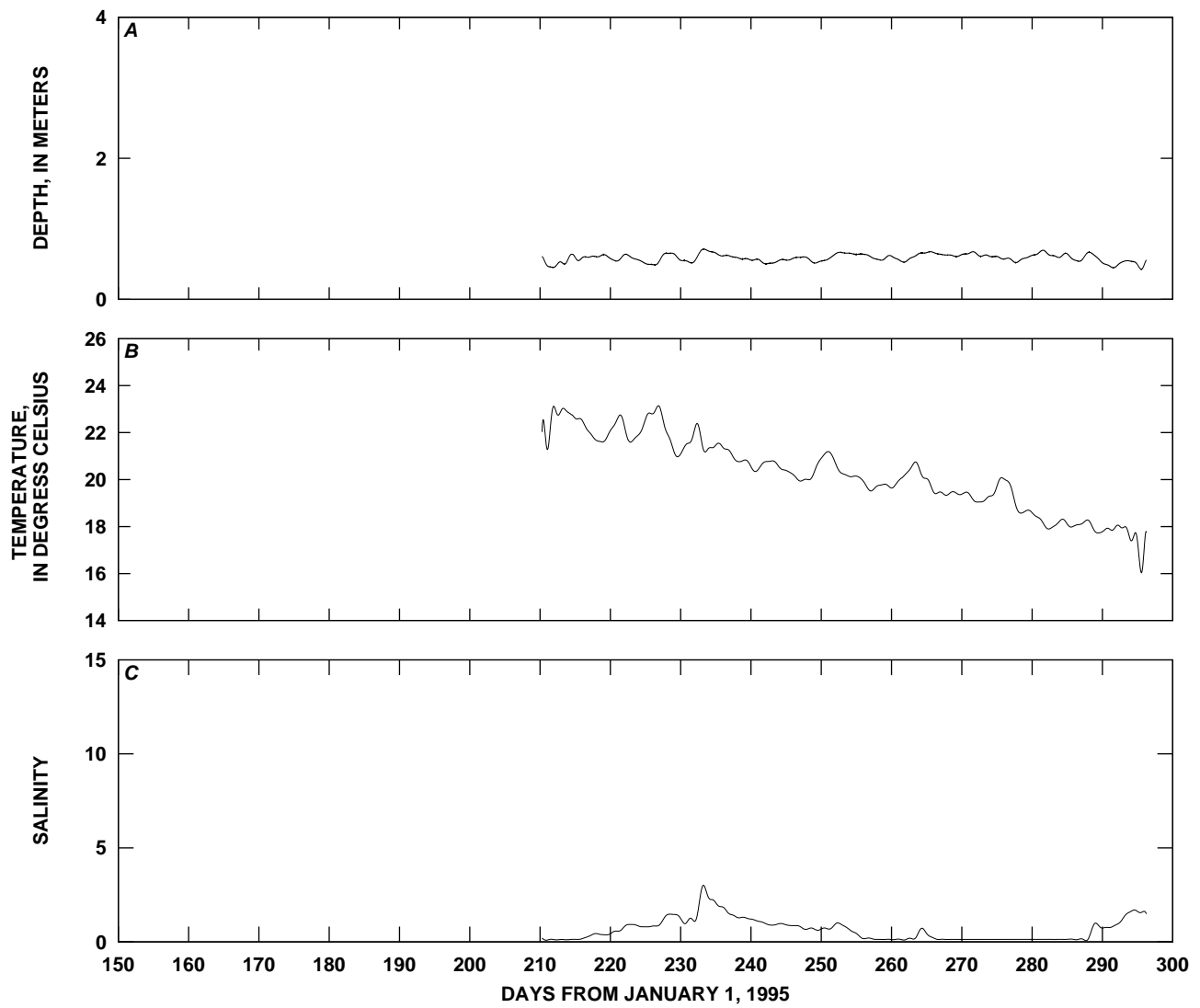

Figure L3. Time-series plots of low-pass-filtered *A*, depth; *B*, temperature; and *C*, salinity, Station HC, July 28 through October 24, 1995, Suisun Bay, California. Salinities in this report are presented without units because salinity is a conductivity ratio; therefore, it has no physical units (Millero, 1993).

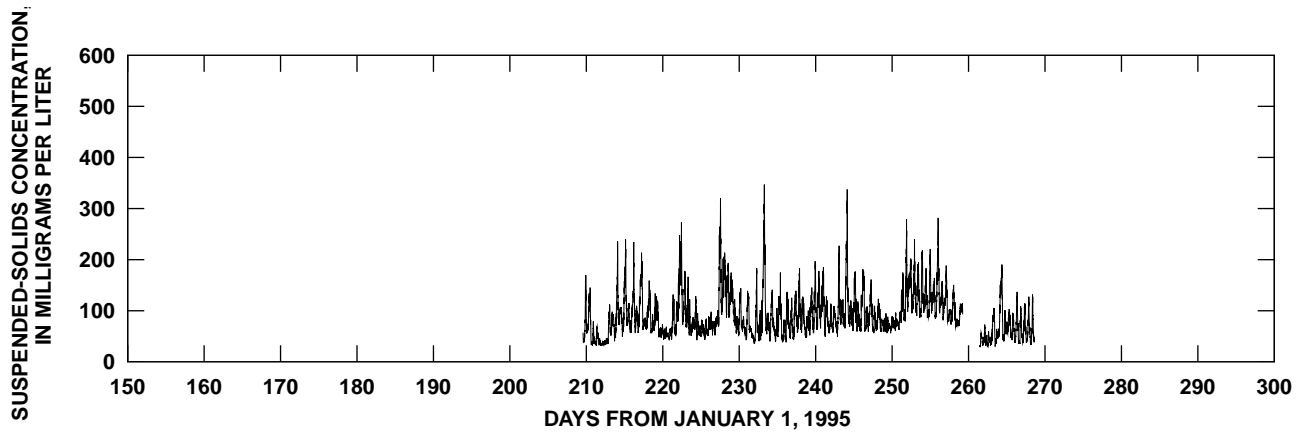

Figure L4. Time-series plot of suspended-solids concentration at Station HC, July 28 through October 24, 1995, Suisun Bay, California.

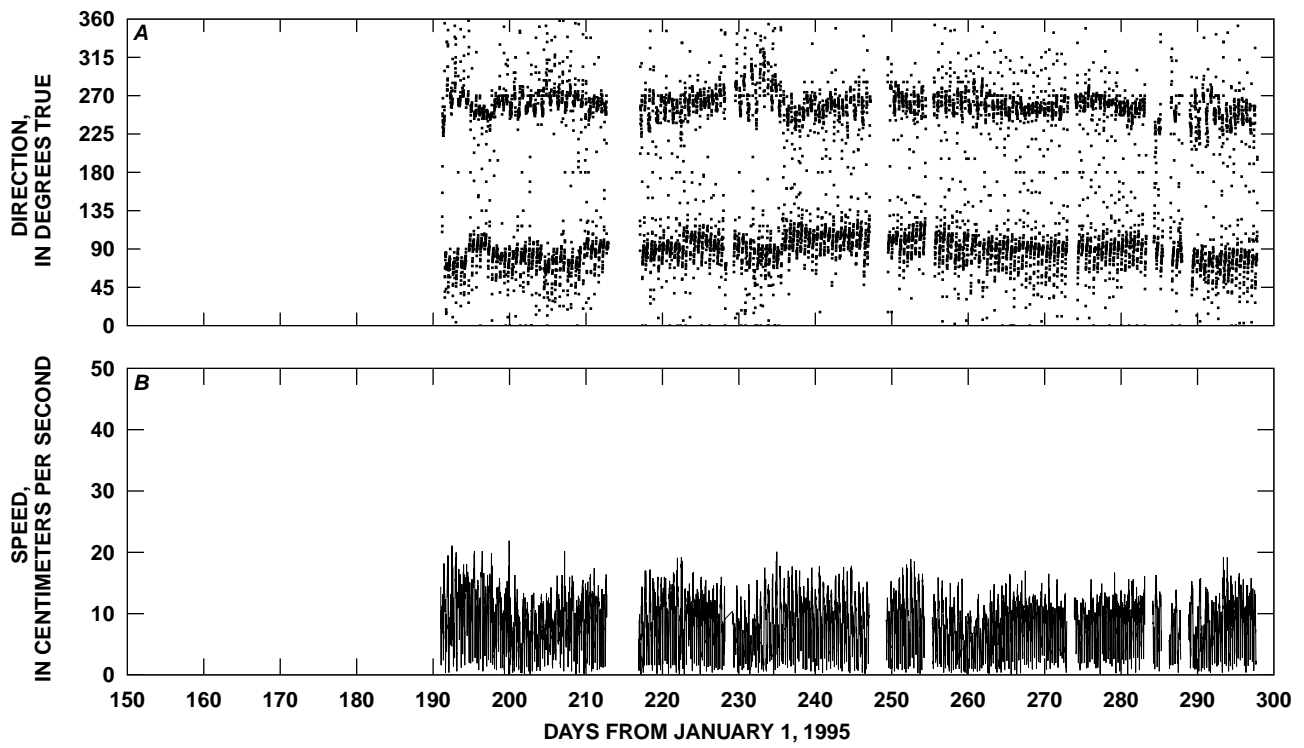

Figure L5. Time-series plots of tidal currents, Station HC, July 9 through October 24, 1995, Suisun Bay, California.

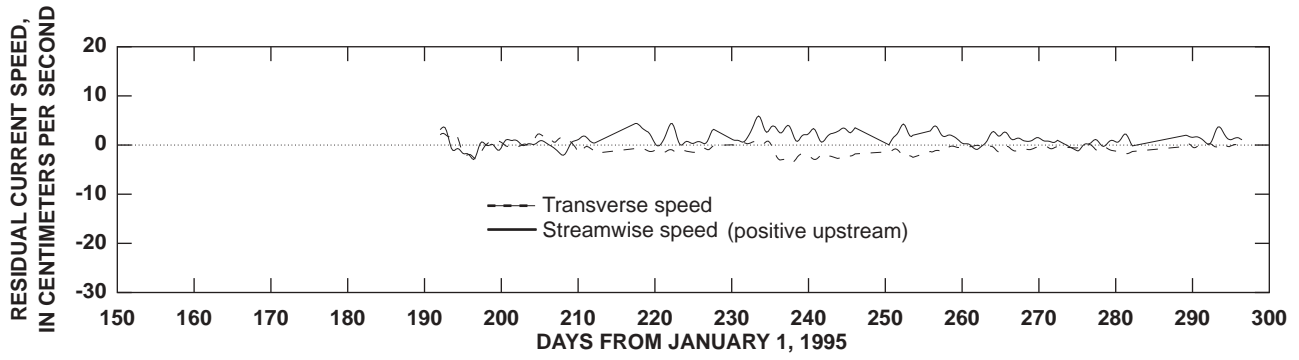

Figure L6. Longitudinal and transverse residual currents, Station HC, July 9 through October 24, 1995, Suisun Bay, California. Principal direction is 80.9 degrees true.

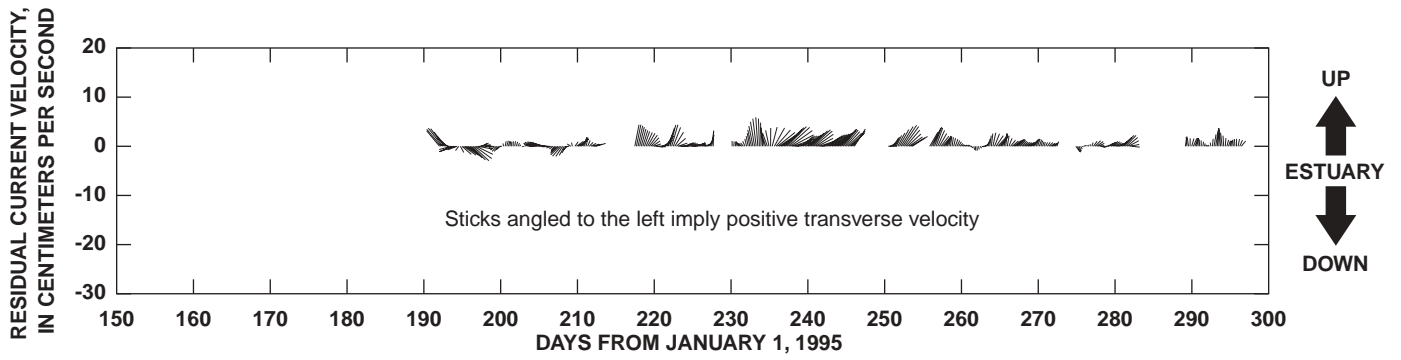

Figure L7. Residual currents, Station HC, July 9 through October 24, 1995, Suisun Bay, California. Principal direction is 80.9 degrees true.

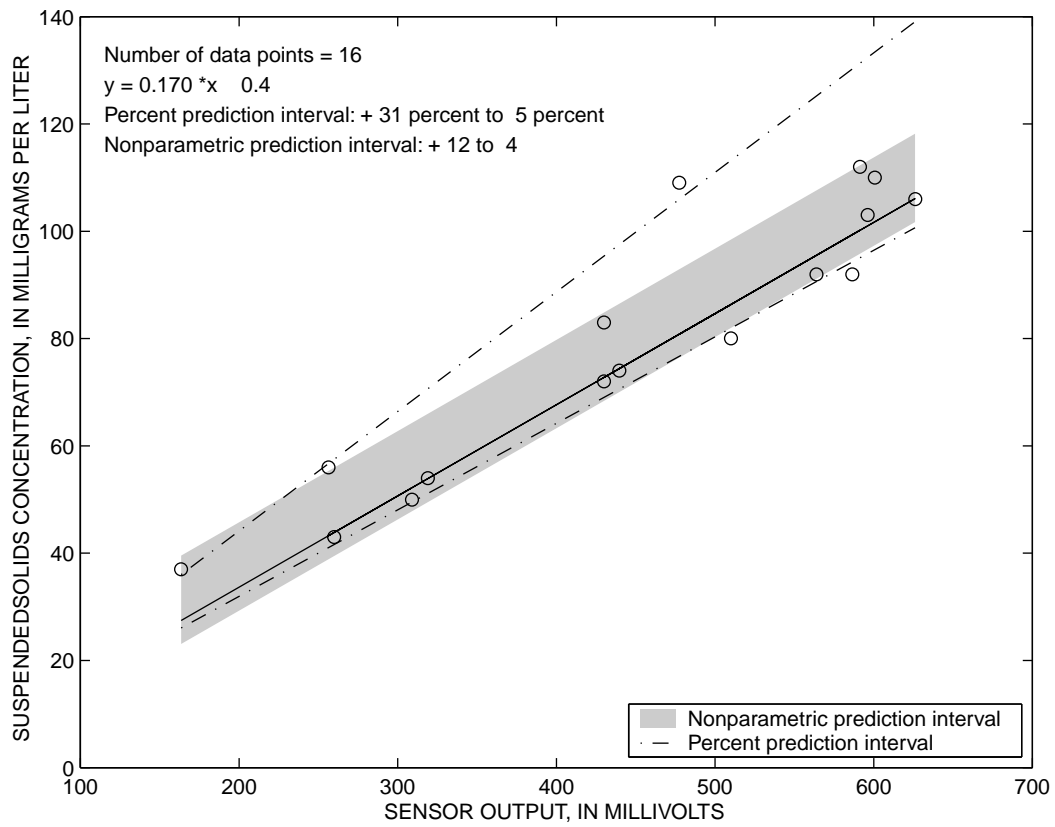

Figure L8. Calibration curve for near-bottom optical backscatterance sensor, Station HC, July 28 through October 24, 1995, Suisun Bay, California.

Table L1. Harmonic analysis results from depth measurements, Station HC, July 28 through October 24, 1995, Suisun Bay, California

Station: HC
Time series mean: 0.58651
Standard deviation: 0.09942
Harmonic constants: After tidal inference

Tidal symbol	Cycles (per day)	Mean amplitude (meters)	Local epoch (degrees)	Modified epoch (degrees)
Q1	0.89324	0.03572	114.55853	129.29840
O1	0.92954	0.18413	112.93835	123.32323
M1	0.96645	0.01307	111.30511	117.26074
P1	0.99726	0.08585	109.91684	112.17456
K1	1.00274	0.25938	109.67184	111.27246
Mu2	1.86455	0.01253	317.05966	337.17233
N2	1.89598	0.09203	336.99097	353.33148
Nu2	1.90084	0.01785	337.17212	352.92981
M2	1.93227	0.52226	338.34293	350.32843
L2	1.96857	0.01462	339.69489	347.32538
S2	2.00000	0.13756	359.62619	3.48450
K2	2.00548	0.03742	1.35013	4.55139
M4	3.86455	0.01813	230.06833	254.03931
Mk3	2.93501	0.02416	28.33594	41.92206

Table L2. Harmonic analysis results for velocity, Station HC, July 9 through October 24, 1995, Suisun Bay, California
[cm/s, centimeters per second; deg.T, degrees true; deg, degrees; E, equilibrium argument]

Station: HC
Start time of the series (local): Year, 95; Month, 7; Day, 28; Hour, 0: 6
Record length: 92 M2 Cycle: 9021 data points

Tidal Symbol	Major axis (cm/s)	Minor axis (cm/s)	Direction (deg. T)	Phase (deg)	E (deg)	Rotation
O1	2.02	0.17	71.8	343.2	125.2	Clockwise
K1	2.56	0.30	75.1	110.0	206.7	Clockwise
N2	1.53	0.01	90.6	55.5	134.3	Counterclockwise
M2	10.56	0.99	83.3	278.8	331.9	Clockwise
S2	2.06	0.54	85.2	21.5	3.3	Clockwise
M4	0.79	0.01	176.7	260.6	303.8	Clockwise

Rootmeansquare speed, (cm/s): 9.31
Standard deviation, U series (cm/s): 3.30
Standard deviation, V series (cm/s): 2.09
Tidal form number: 0.36
Spring tidal current maximum (cm/s): 17.21
Neap tidal current maximum (cm/s): 7.97
Principal current direction (deg. T): 80.94

APPENDIX M—STATION HDOL

Station Name: **HDOL**
(Honker Bay at the dolphin)

Position: Lat. 38°04'25"

Long. 121°57'27"

Depth: 1.9 m (MLLW)

Manufacturer	Serial Number	Deployment Dates
CT: Seabird	SeacatNA	7/6/95(187) - 9/18/95(261)
VTD: E G & G	ACM316356	7/6/95(187) - 9/18/95(261)
OBS: D & A	OBS3 309	7/6/95(187) - 9/18/95(261)

Serviced: 7/6/95(187), 7/11/95(192), 7/25/95(206), 8/2/95(214), 8/9/95(221), 9/18/95(261)

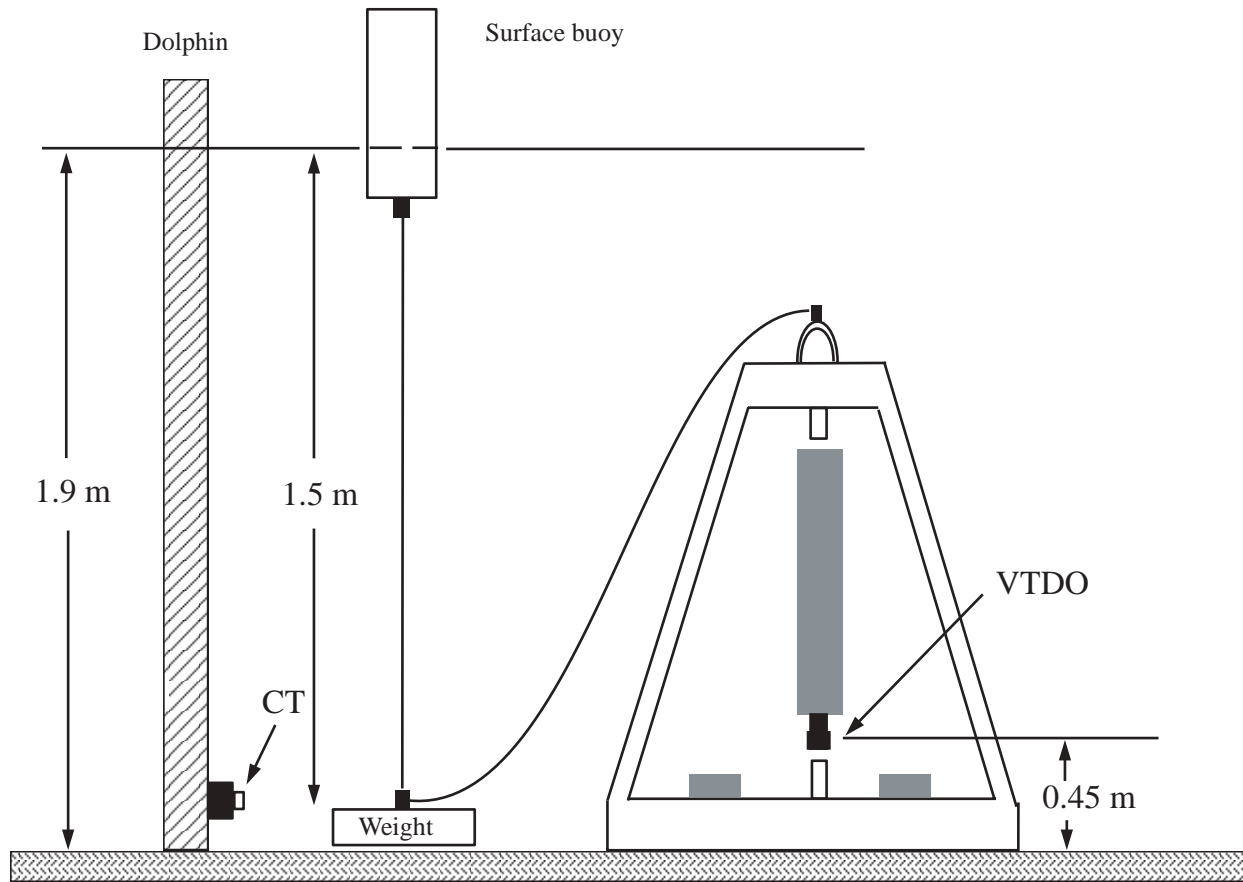

Figure M1. Configuration of instrument deployment, Station HDOL, July 6 through September 18, 1995, Suisun Bay, California. m, meters; MLLW, mean lower low water; OBS, optical backscatterance sensor; CT, conductivity-temperature; VTD, velocity-temperature-depth; VTDO, velocity-temperature-depth-optical (backscatterance sensor).

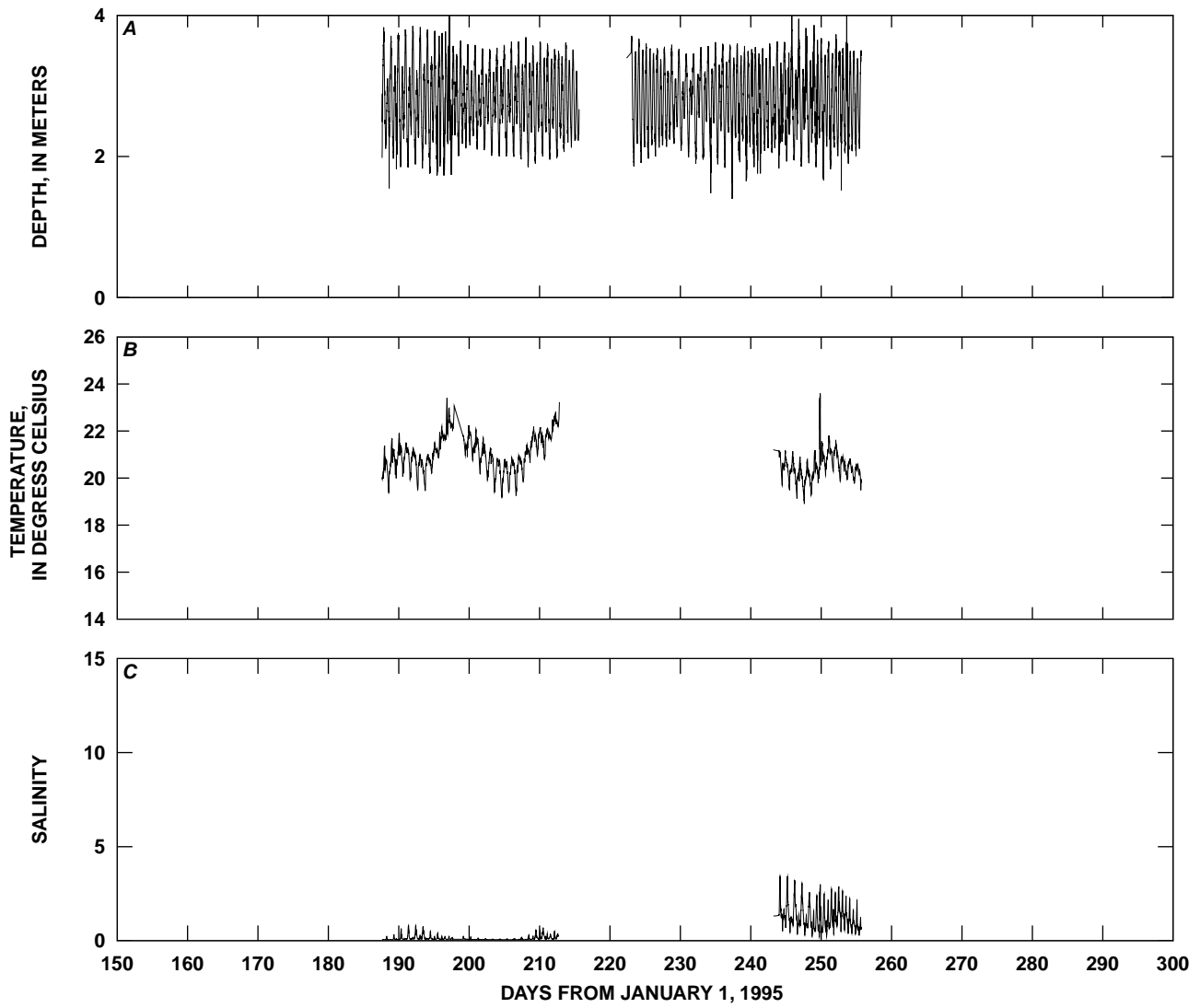

Figure M2. Time-series plots of *A*, depth; *B*, temperature; and *C*, salinity, Station HDOL, July 6 through September 18, 1995, Suisun Bay, California. Salinities in this report are presented without units because salinity is a conductivity ratio; therefore, it has no physical units (Millero, 1993).

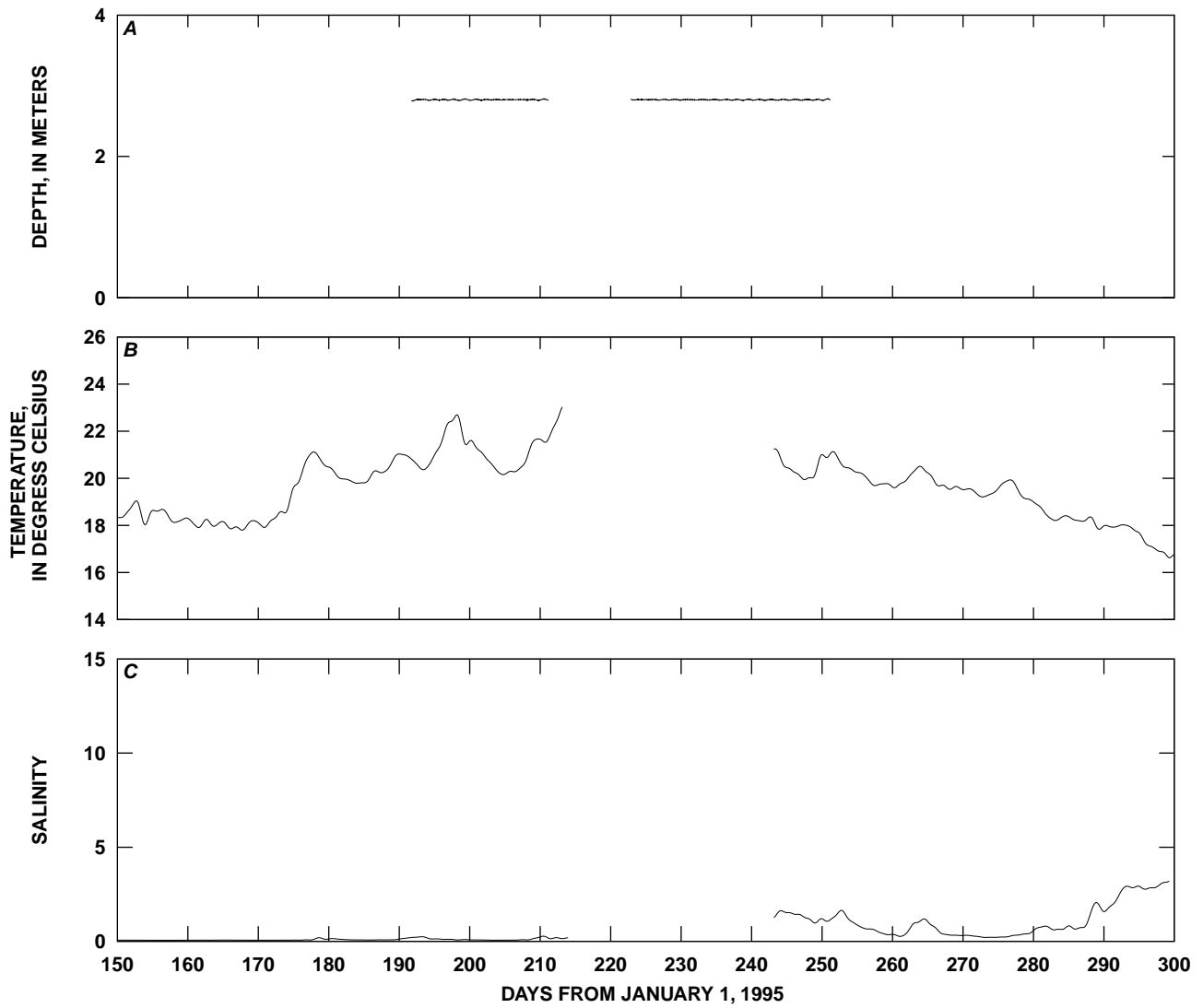

Figure M3. Time-series plots of low-pass-filtered *A*, depth; *B*, temperature; and *C*, salinity, Station HDOL, July 6 through September 18, 1995, Suisun Bay, California. Salinities in this report are presented without units because salinity is a conductivity ratio; therefore, it has no physical units (Millero, 1993).

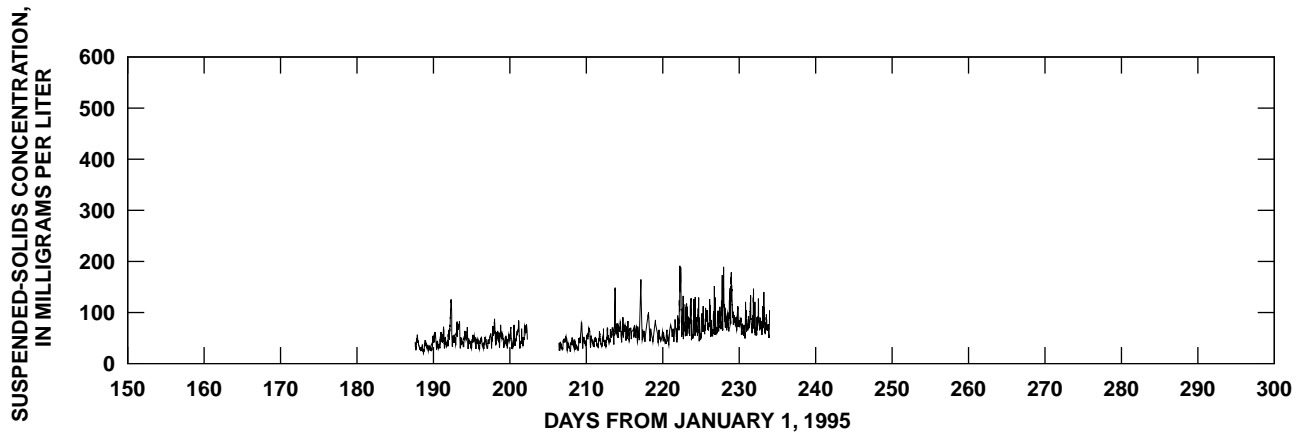

Figure M4. Time-series plot of suspended-solids concentration at Station HDOL, July 6 through September 18, 1995, Suisun Bay, California.

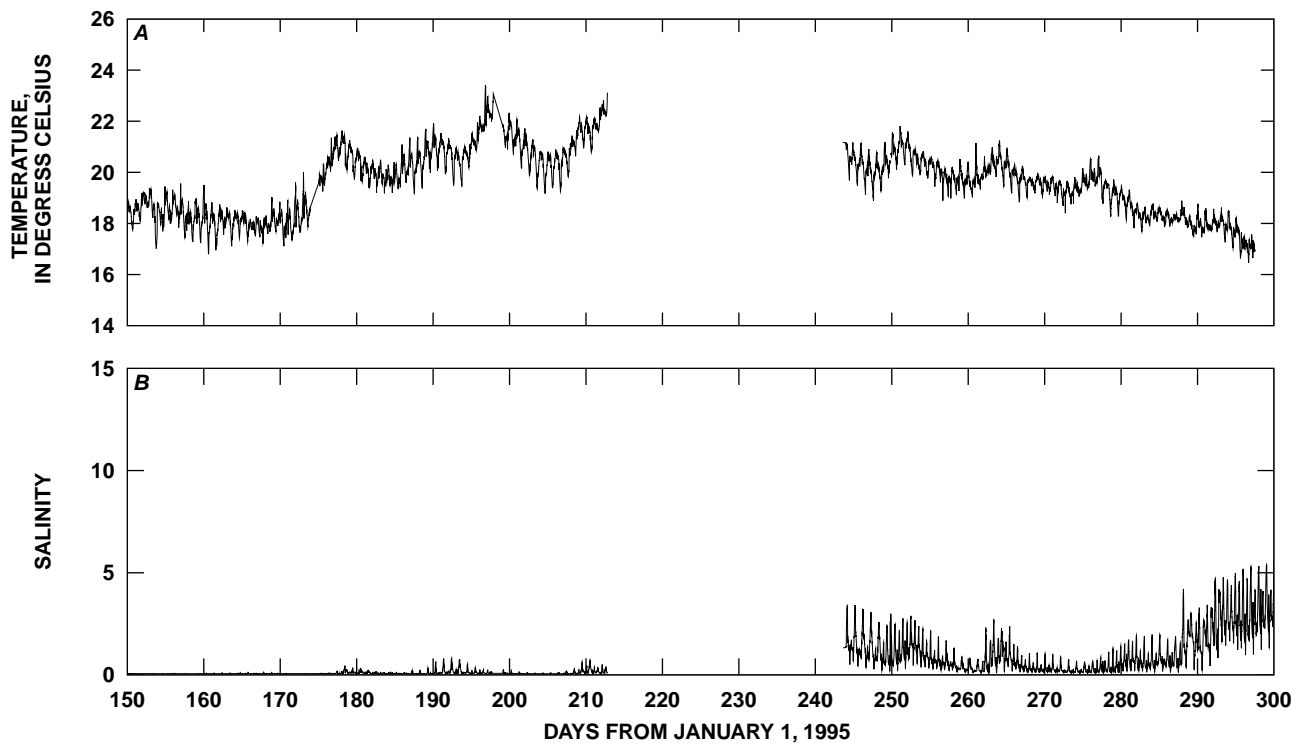

Figure M5. Time-series plots of *A*, temperature; and *B*, salinity, Station HDOL (collected by National Oceanic and Atmospheric Administration), April 30 through November 3, 1995, Suisun Bay, California. Salinities in this report are presented without units because salinity is a conductivity ratio; therefore, it has no physical units (Millero, 1993).

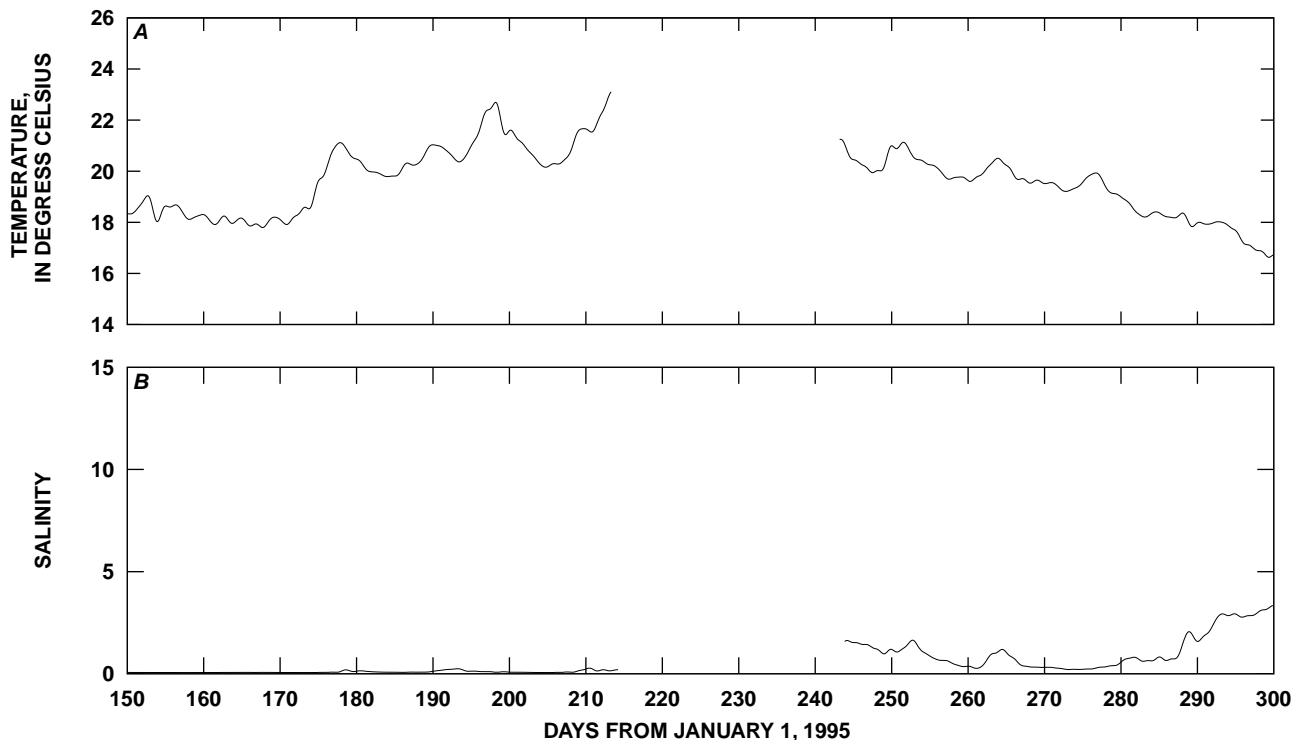

Figure M6. Time-series plots of low-pass-filtered *A*, temperature; and *B*, salinity, Station HDOL (collected by National Oceanic and Atmospheric Administration), April 30 through November 3, 1995, Suisun Bay, California. Salinities in this report are presented without units because salinity is a conductivity ratio; therefore, it has no physical units (Millero, 1993).

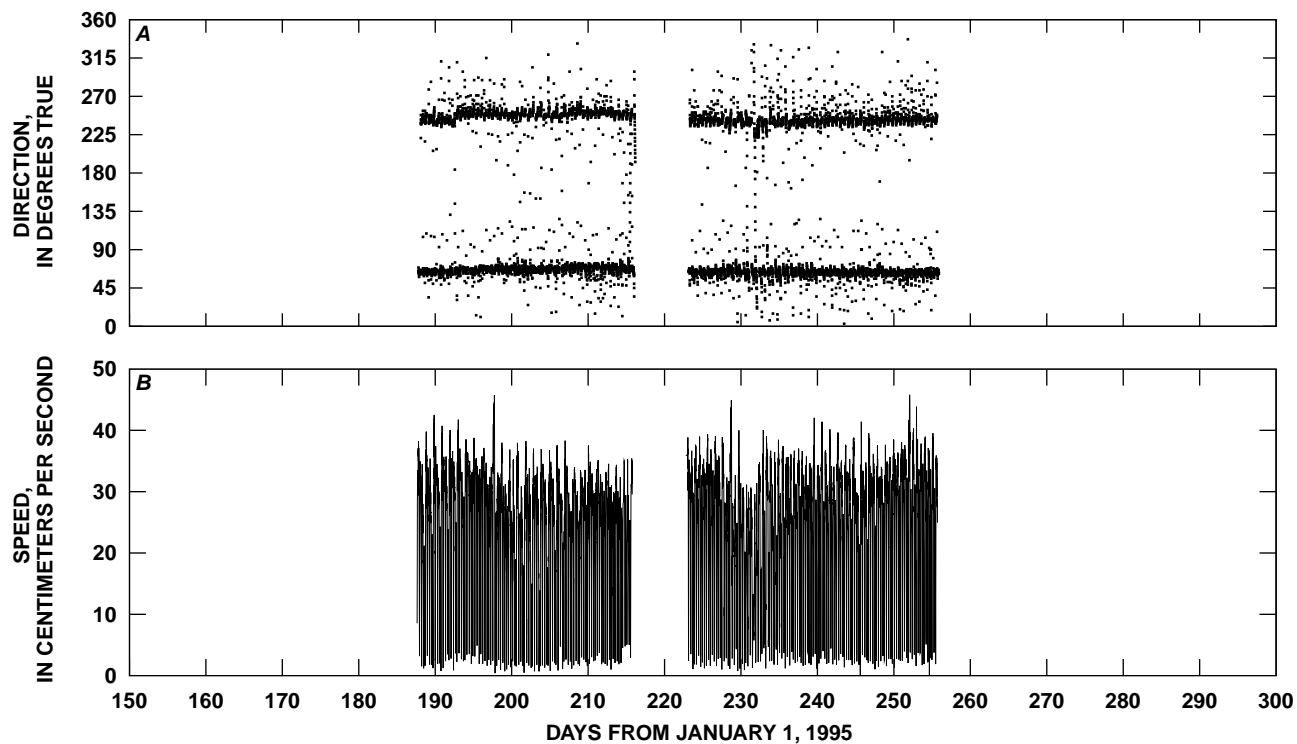

Figure M7. Time-series plots of tidal currents, Station HDOL, July 6 through September 18, 1995, Suisun Bay, California.

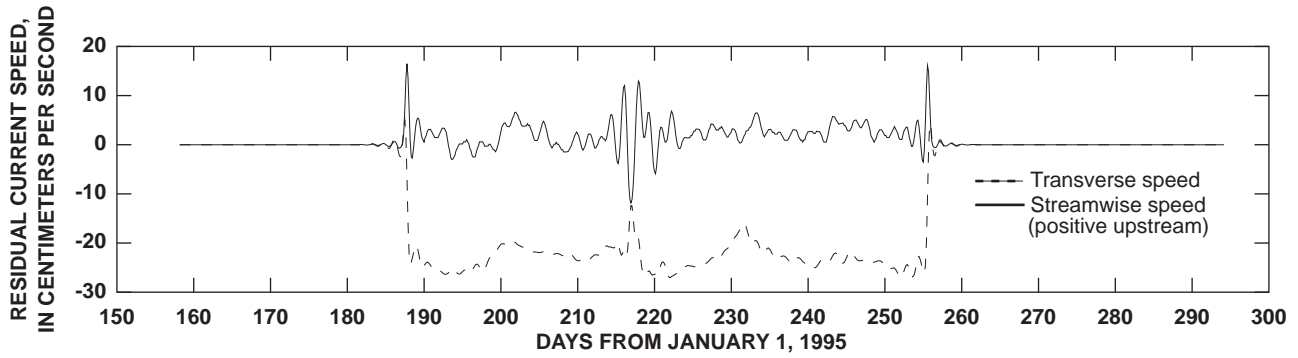

Figure M8. Longitudinal and transverse residual currents, Station HDOL, July 6 through September 18, 1995, Suisun Bay, California. Principal direction is 63.3 degrees true.

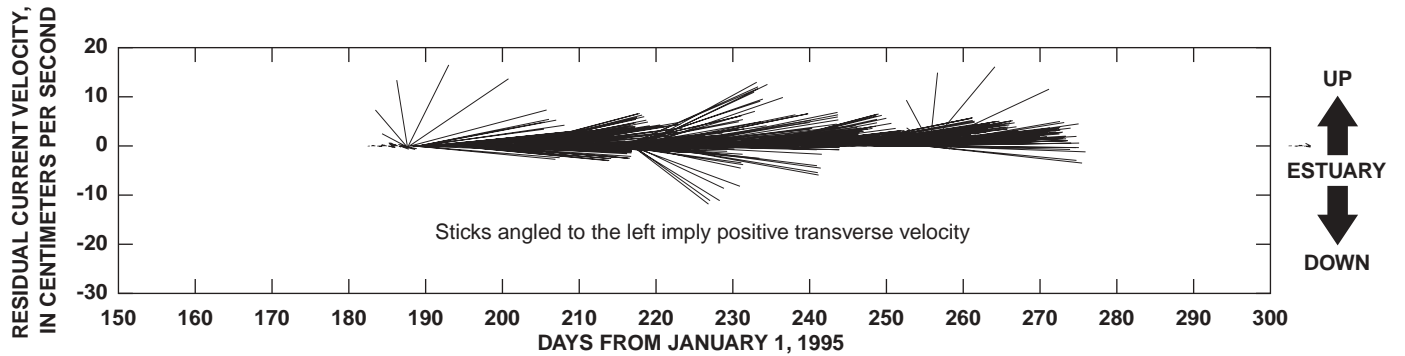

Figure M9. Residual currents, Station HDOL, July 6 through September 18, 1995, Suisun Bay, California. Principal direction is 63.3 degrees true.

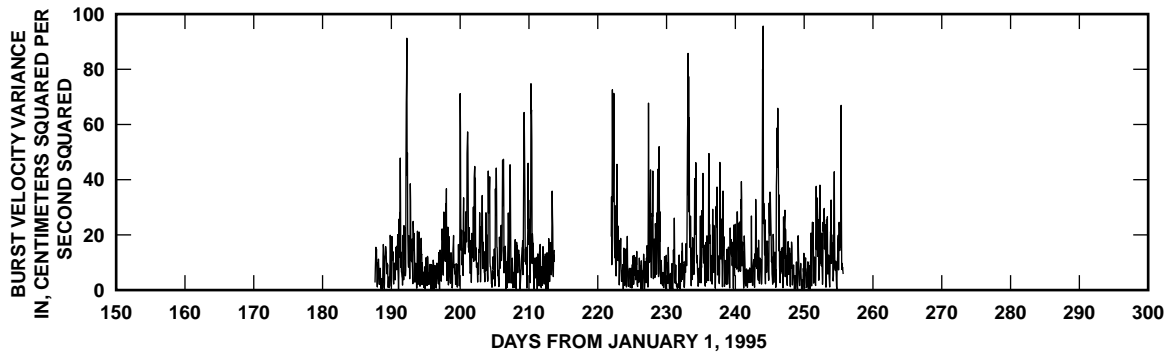

Figure M10. Burst velocity variance, Station HDOL, July 6 through September 18, 1995, Suisun Bay, California. Every hour output from the velocity sensor was stored every 0.5 second over a 128-second period in order to measure the wind-wave properties. Periodic, short, and intensive data-collection strategies are called burst sampling and are used to measure high-frequency processes that cannot be continuously recorded because of data-storage limitations. The variance of velocity for each burst sample is an approximate measure of the wind-wave energy.

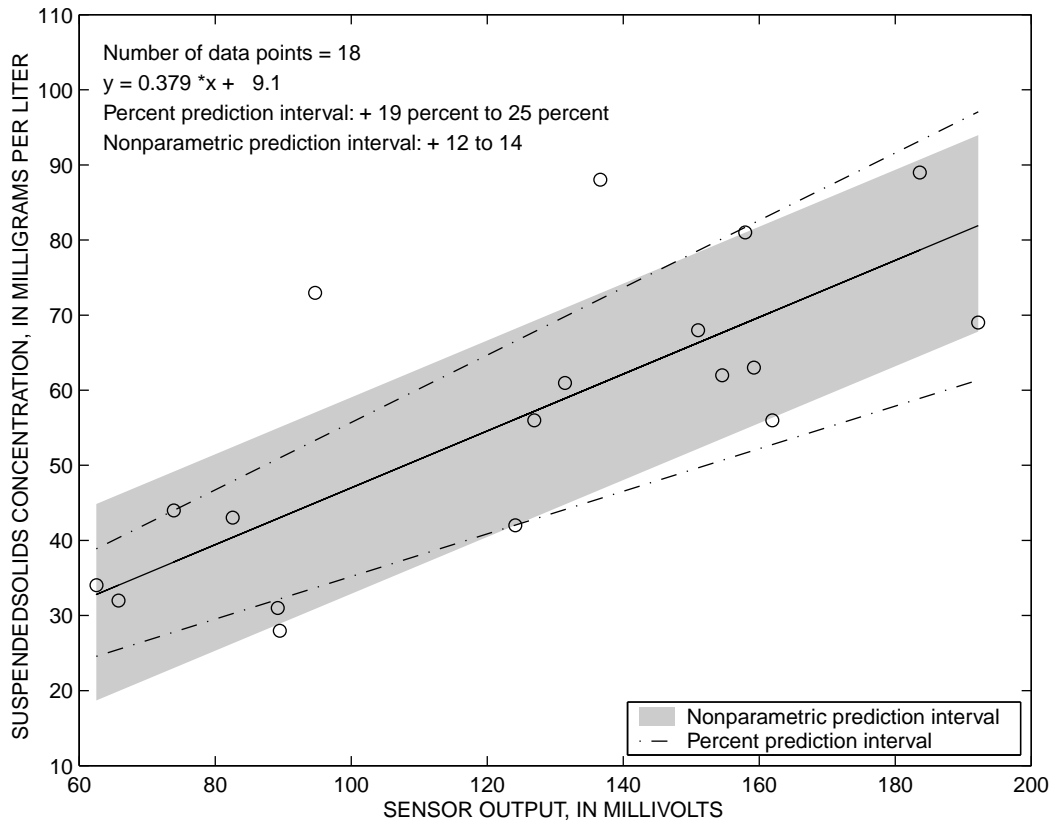

Figure M11. Calibration curve for near-bottom optical backscatterance sensor, Station HDOL, July 6 through September 18, 1995, Suisun Bay, California.

Table M1. Harmonic analysis results from depth measurements, Station HDOL, July 6 through September 18, 1995, Suisun Bay, California

Station: HDOL
 Time series mean: 2.80257
 Standard deviation: 0.11356
 Harmonic constants: After tidal inference

Tidal symbol	Cycles (per day)	Mean amplitude (meters)	Local epoch (degrees)	Modified epoch (degrees)
Q1	0.89324	0.03588	133.70499	148.47318
O1	0.92954	0.18493	166.27049	176.68370
M1	0.96645	0.01313	199.09863	205.08258
P1	0.99726	0.07305	227.00253	229.28857
K1	1.00274	0.22068	231.92676	233.55571
Mu2	1.86455	0.01297	253.82581	273.99512
N2	1.89598	0.02942	247.62512	264.02228
Nu2	1.90084	0.00571	230.51917	246.33350
M2	1.93227	0.54039	119.96887	132.01105
L2	1.96857	0.01513	352.31262	359.99979
S2	2.00000	0.08863	346.11197	350.02695
K2	2.00548	0.02411	335.26956	338.52747
M4	3.86455	0.01963	172.11658	196.20087
Mk3	2.93501	0.03465	282.46506	296.13617

Table M2. Harmonic analysis results for velocity, Station HDOL, July 6 through September 18, 1995, Suisun Bay, California

[cm/s, centimeters per second; deg.T, degrees true; deg, degrees; E, equilibrium argument]

Station: HDOL
 Start time of the series (local): Year, 95; Month, 5; Day, 1; Hour, 0: 0
 Record length: 60 M2 Cycle: 8795 data points

Tidal Symbol	Major axis (cm/s)	Minor axis (cm/s)	Direction (deg. T)	Phase (deg)	E (deg)	Rotation
O1	6.45	0.00	62.3	116.6	196.0	Counterclockwise
K1	9.50	0.05	62.6	165.0	118.3	Clockwise
N2	5.38	0.02	62.4	237.6	186.4	Counterclockwise
M2	29.48	0.07	64.8	86.8	314.2	Counterclockwise
S2	5.58	0.30	66.5	300.6	0.0	Clockwise
M4	0.51	0.04	59.2	357.0	268.4	Clockwise

Rootmeansquare speed, (cm/s): 25.20
 Standard deviation, U series (cm/s): 6.63
 Standard deviation, V series (cm/s): 3.53
 Tidal form number: 0.45
 Spring tidal current maximum (cm/s): 51.01
 Neap tidal current maximum (cm/s): 20.84
 Principal current direction (deg. T): 64.26

THIS PAGE LEFT BLANK INTENTIONALLY

APPENDIX N—STATION HS

Station Name: **HS**
 (Honker Bay South East side)

Position: Lat. 38°03'28"

Long. 121°55'59"

Depth: 1.1 m (MLLW)

Manufacturer	Serial Number	Deployment Dates
CTD: Ocean Sensors	OS200 304	8/1/95(213) - 9/18/95(261)
V: InterOcean	S405451272	7/7/95(188) - 9/18/95(261)
OBS: D & A	OBS3 613	8/1/95(213) - 9/18/95(261)

Serviced: 7/7/95(188), 8/1/95(213), 8/10/95(222), 8/23/95(235), 9/18/95(261)

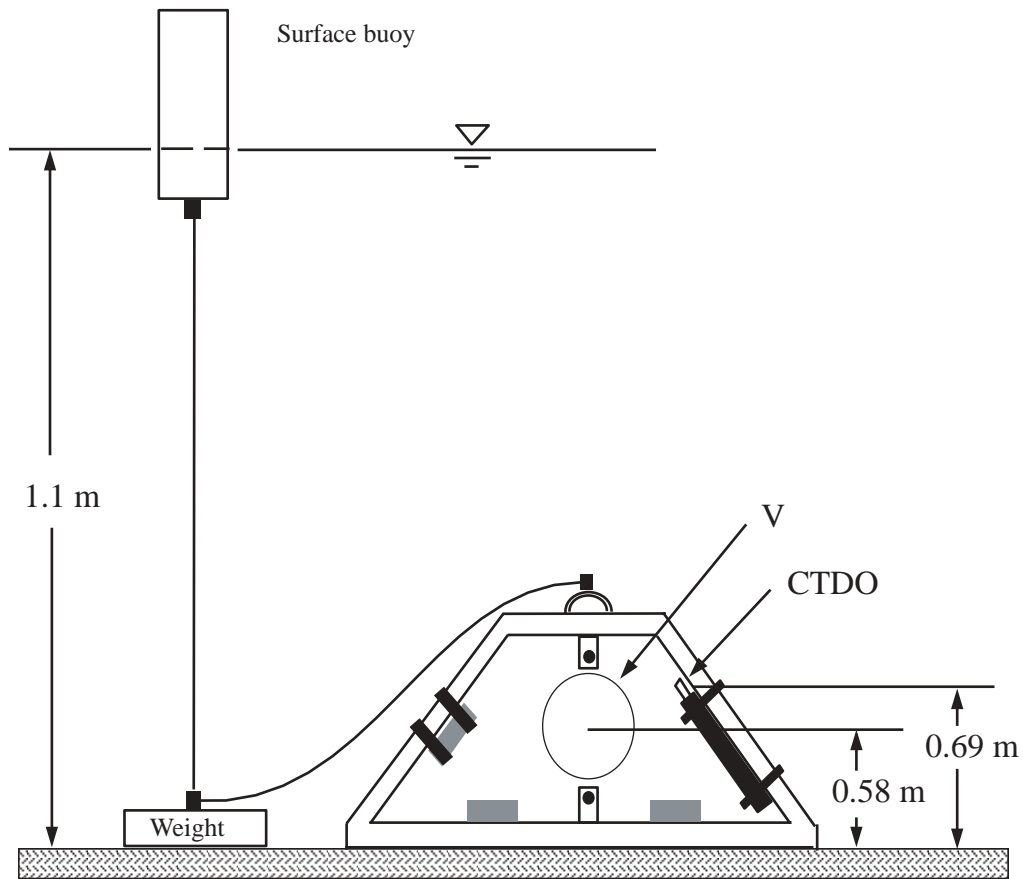

Figure N1. Configuration of instrument deployment, Station HS, July 7 through September 18, 1995, Suisun Bay, California. m, meters; MLLW, mean lower low water; OBS, optical backscatterance sensor; CTD, conductivity-temperature-depth; CTDO, conductivity-temperature-depth-optical (backscatterance sensor); V, velocity.

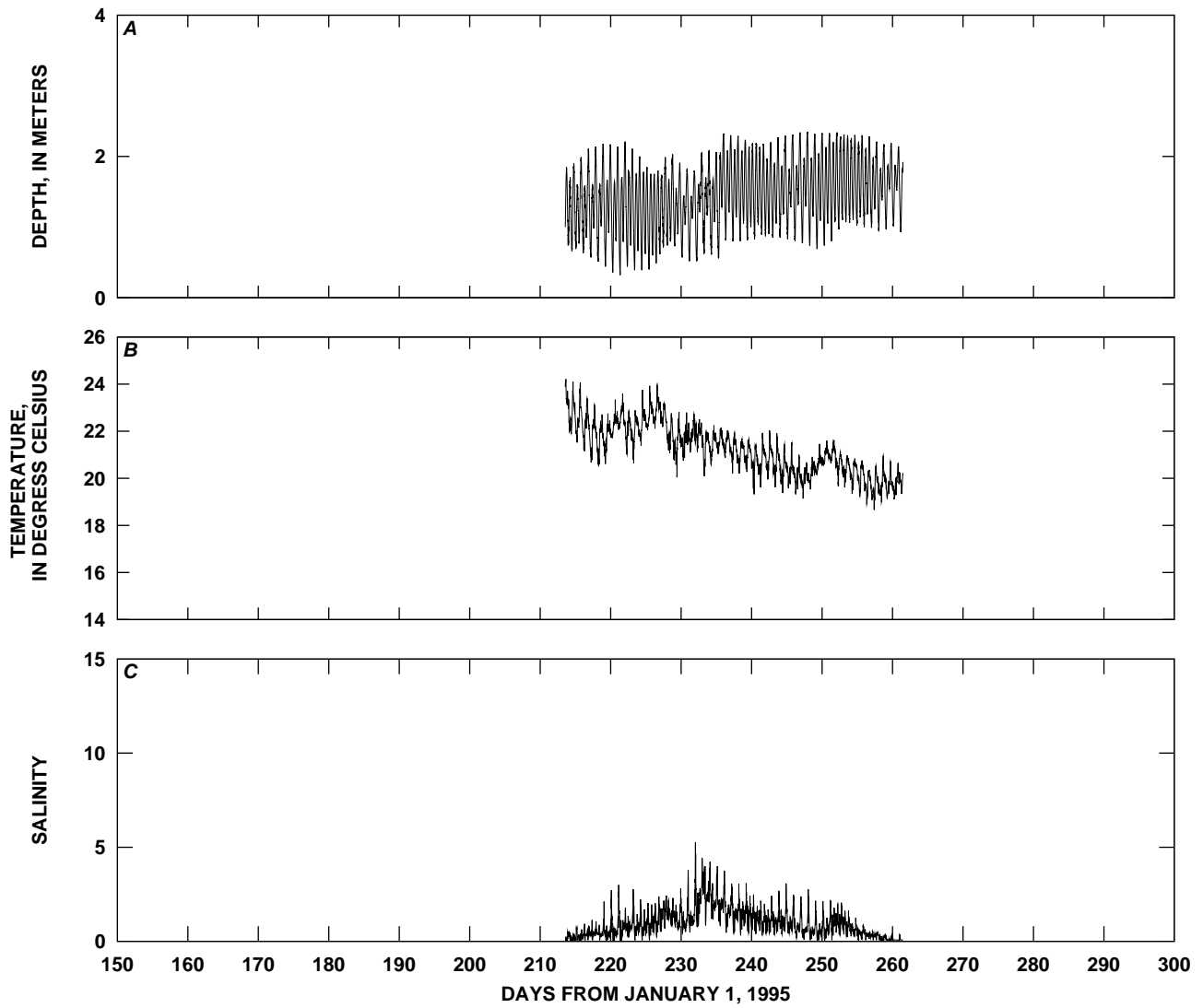

Figure N2. Time-series plots of *A*, depth; *B*, temperature; and *C*, salinity, Station HS, August 1 through September 18, 1995, Suisun Bay, California. Salinities in this report are presented without units because salinity is a conductivity ratio; therefore, it has no physical units (Millero, 1993).

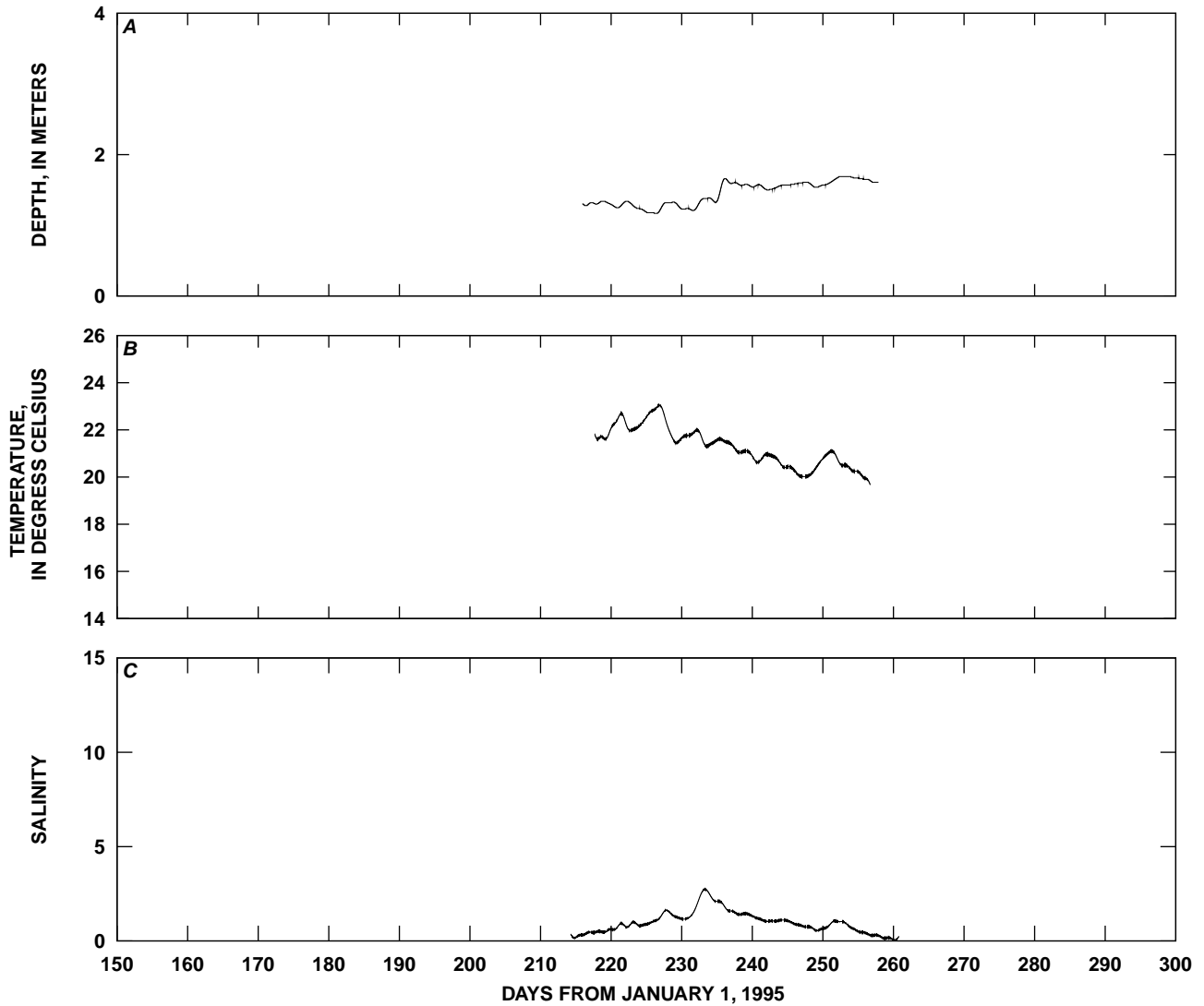

Figure N3. Time-series plots of low-pass-filtered *A*, depth; *B*, temperature; and *C*, salinity, Station HS, August 1 through September 18, 1995, Suisun Bay, California. Salinities in this report are presented without units because salinity is a conductivity ratio; therefore, it has no physical units (Millero, 1993).

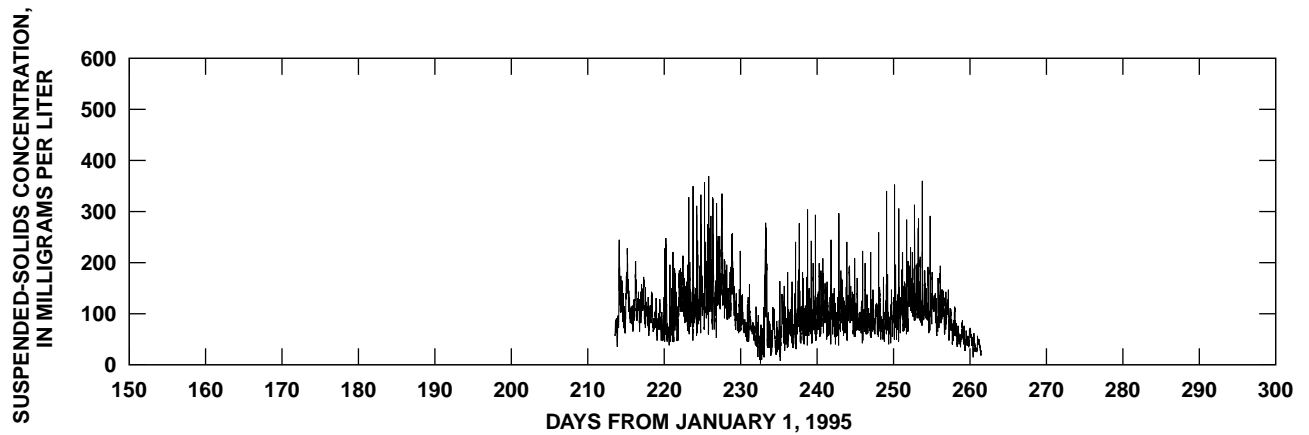

Figure N4. Time-series plot of suspended-solids concentration, Station HS, August 1 through September 18, 1995, Suisun Bay, California.

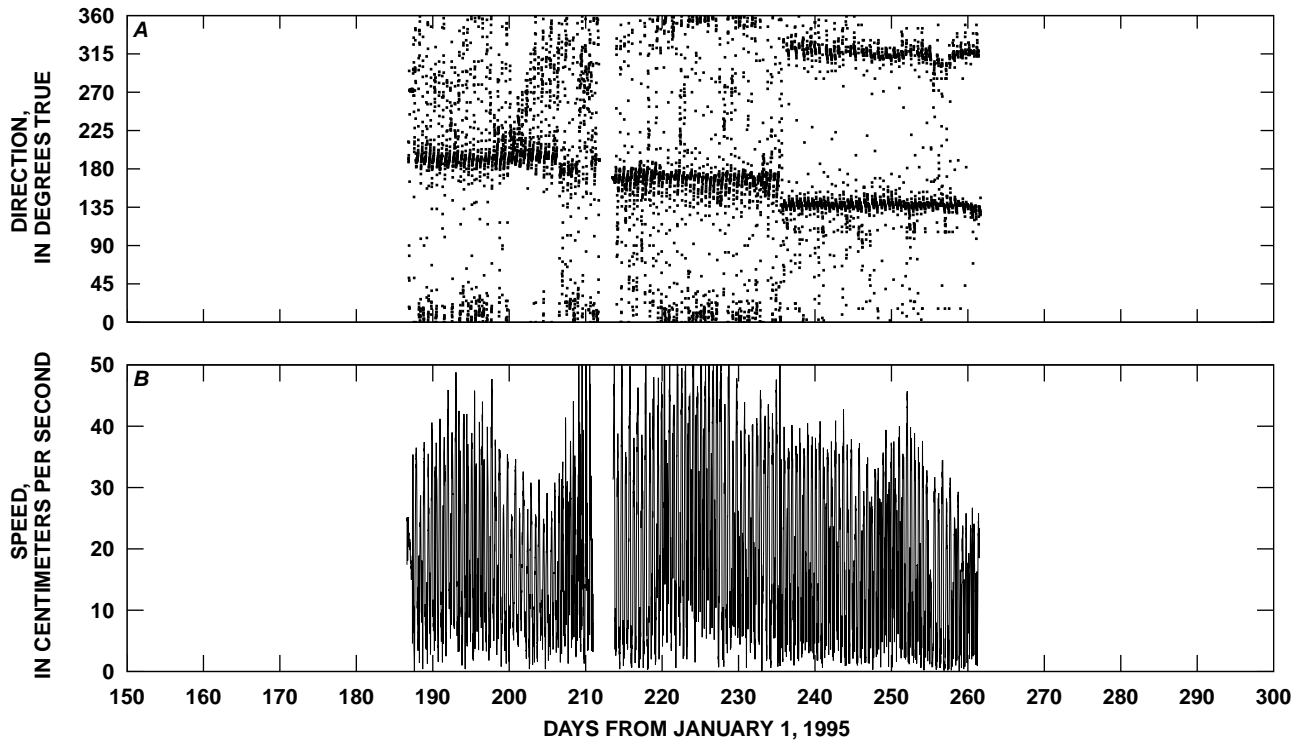

Figure N5. Time-series plots of tidal currents, Station HS, July 7 through September 18, 1995, Suisun Bay, California.

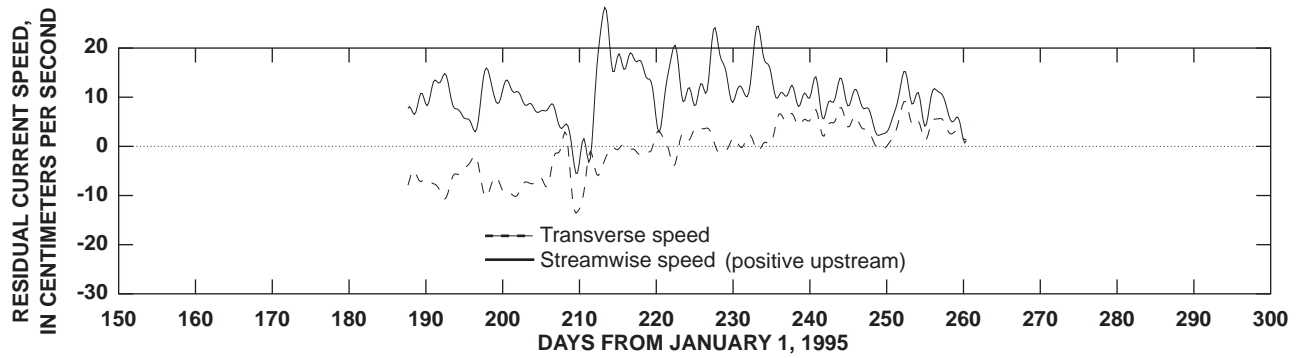

Figure N6. Longitudinal and transverse residual currents, Station HS, July 7 through September 18, 1995, Suisun Bay, California. Principal direction is 164.7 degrees true.

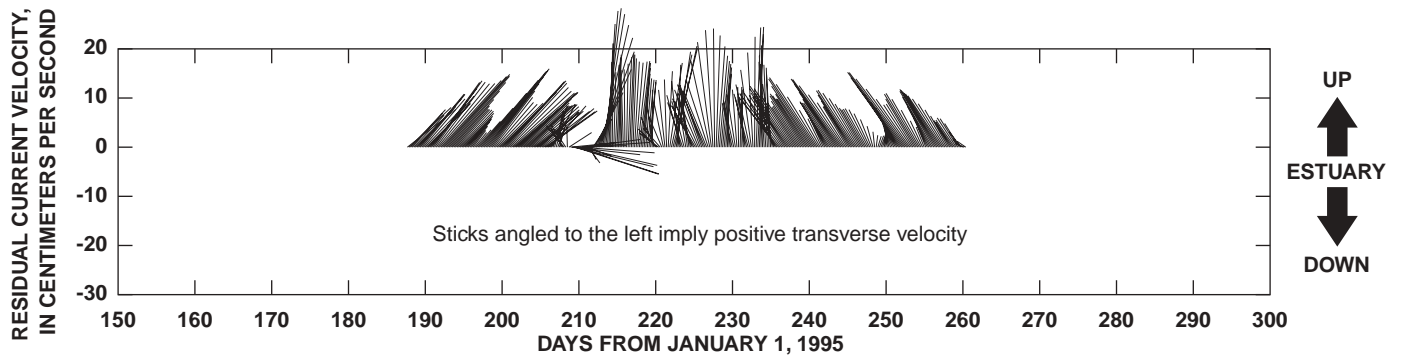

Figure N7. Residual currents, Station HS, July 7 through September 18, 1995, Suisun Bay, California. Principal direction is 164.7 degrees true.

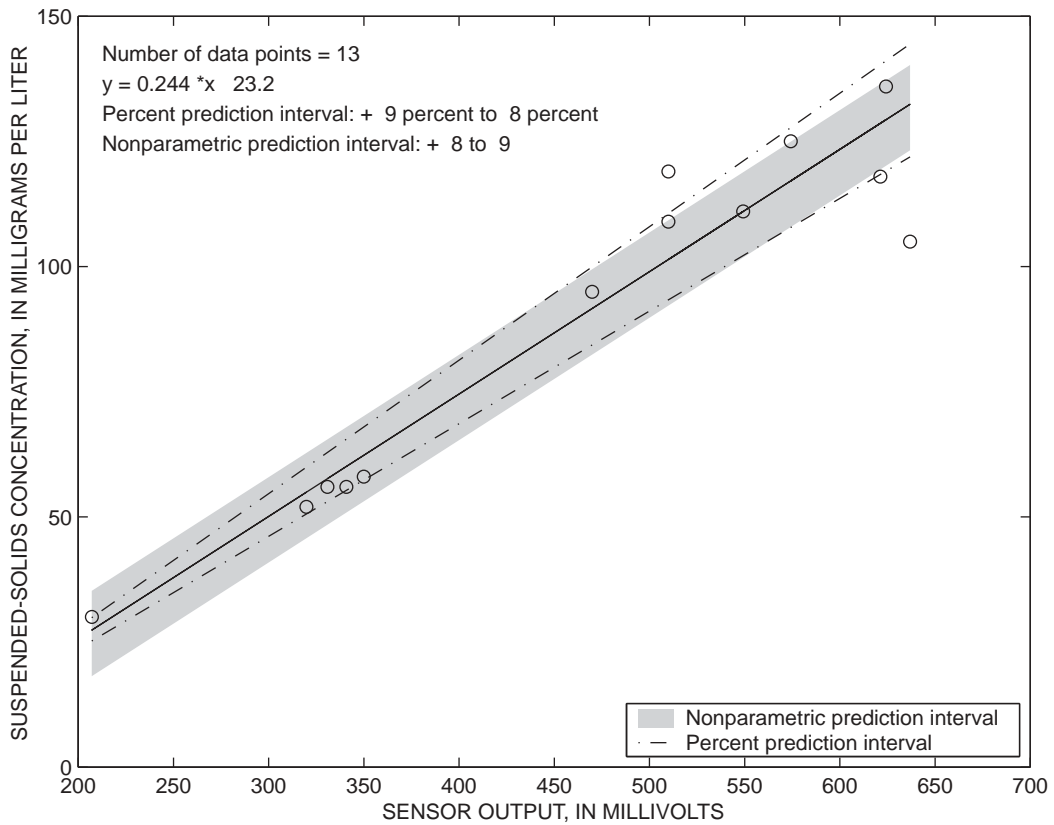

Figure N8. Calibration curve for near-bottom optical backscatterance sensor, Station HS, August 1 through September 18, 1995, Suisun Bay, California.

Table N1. Harmonic analysis results from depth measurements, Station HS, August 1 through September 18, 1995, Suisun Bay, California

Station: HS
Time series mean: 1.45560
Standard deviation: 0.17919
Harmonic constants: After tidal inference

Tidal symbol	Cycles (per day)	Mean amplitude (meters)	Local epoch (degrees)	Modified epoch (degrees)
Q1	0.89324	0.03570	106.78165	121.52539
O1	0.92954	0.18403	109.30936	119.69812
M1	0.96645	0.01307	111.85742	117.81693
P1	0.99726	0.08244	114.02332	116.28491
K1	1.00274	0.24906	114.40552	116.01001
Mu2	1.86455	0.01174	312.67090	332.79132
N2	1.89598	0.04208	49.45496	65.80322
Nu2	1.90084	0.00816	40.18210	55.94754
M2	1.93227	0.48919	340.25446	352.24774
L2	1.96857	0.01370	271.05396	278.69223
S2	2.00000	0.16641	7.83801	11.70410
K2	2.00548	0.04526	10.07227	13.28128
M4	3.86455	0.02089	236.64197	260.62848
Mk3	2.93501	0.02316	38.60767	52.20544

Table N2. Harmonic analysis results for velocity, Station HS, July 7 through September 18, 1995, Suisun Bay, California
[cm/s, centimeters per second; deg.T, degrees true; deg, degrees; E, equilibrium argument]

Station: HS
Start time of the series (local): Year, 95; Month, 7; Day, 30; Hour, 0: 7
Record length: 73 M2 Cycle: 7187 data points

Tidal Symbol	Major axis (cm/s)	Minor axis (cm/s)	Direction (deg. T)	Phase (deg)	E (deg)	Rotation
O1	4.51	0.58	160.8	358.3	74.6	Clockwise
K1	5.85	0.64	169.0	297.2	208.8	Clockwise
N2	3.96	0.22	171.1	88.4	59.7	Clockwise
M2	19.00	2.12	164.0	61.5	283.4	Clockwise
S2	4.23	0.07	166.3	340.0	3.6	Counterclockwise
M4	2.66	0.53	173.3	114.0	206.8	Clockwise

Rootmeansquare speed, (cm/s): 23.69
Standard deviation, U series (cm/s): 9.63
Standard deviation, V series (cm/s): 10.90
Tidal form number: 0.45
Spring tidal current maximum (cm/s): 33.59
Neap tidal current maximum (cm/s): 13.44
Principal current direction (deg. T): 164.72

THIS PAGE LEFT BLANK INTENTIONALLY